

User's Manual

INFIRAY OUTDOOR

RICO V2

Rugged Infrared Compact Optic



WARNING! ITAR REQUIREMENTS

These products may be subject to export and foreign trade control laws of the United States and may not be exported without prior approval of the U.S. Department of State. Learn more at irayusa.com/ITAR.

FCC ID: 2AYGT-RICO

This device complies with part 15 of the FCC Rules. Operation is subject to the following two conditions: (1) This device may not cause harmful interference, and (2) this device must accept any interference received, including interference that may cause undesired operation.

CAUTION: Changes or modifications not expressly approved by IRayUSA could void the user's authority to operate the equipment.

NOTE: This equipment has been tested and found to comply with the limits for a Class B digital device, pursuant to part 15 of the FCC Rules. These limits are designed to provide reasonable protection against harmful interference in a residential installation. This equipment generates, uses and can radiate radio frequency energy and, if not installed and used in accordance with the instructions, may cause harmful interference to radio communications. However, there is no guarantee that interference will not occur in a particular installation. If this equipment does cause harmful interference to radio or television reception, which can be determined by turning the equipment off and on, the user is encouraged to try to correct the interference by one or more of the following measures:

- Reorient or relocate the receiving antenna.
- Increase the separation between the equipment and receiver.
- Connect the equipment into an outlet on a circuit different from that to which the receiver is connected.
- Consult the dealer or an experienced radio/TV technician for help.

This device was tested for typical body-supported operations and use. To comply with RF exposure requirements, a minimum separation distance of 0.5cm must be maintained between the user's body and the handset, including the antenna. Third-party belt-clips, holsters, and similar accessories used by this device should not contain any metallic components. Body accessories that do not meet these requirements may not comply with RF exposure requirements and should be avoided. Use only the supplied or an approved antenna.

WARNING: CHOKING HAZARD

Children under 3 years old can choke or suffocate on small parts of this product. This product is not a toy; keep out of reach of children.

TABLE OF CONTENTS

| | |
|---|----|
| 1. Overview | 2 |
| 2. Features | 2 |
| 3. Tech Specs | 3 |
| 4. Accessories | 4 |
| 5. Components and Controls | 5 |
| 6. Description of Control Buttons & Shortcuts ... | 6 |
| 7. Quick Start Guide | 8 |
| 8. Charging the Battery Pack | 10 |
| 9. Installing the Battery Pack..... | 11 |
| 10. Removing the Battery Pack..... | 12 |
| 11. Battery Safety Warnings | 12 |
| 12. External Power Supply | 13 |
| 13. Mounting the RICO V2 | 13 |
| 14. Operating Instructions | 15 |
| 15. Zeroing the RICO V2 | 20 |
| 16. Non-Uniformity Correction..... | 21 |
| 17. Photography and Video Recording | 22 |
| 18. Accessing the Internal Memory | 24 |
| 19. Video Output..... | 24 |
| 20. Using the InfiRay Outdoor App..... | 25 |
| 21. Digital Zoom | 26 |
| 22. Picture in Picture (PIP)..... | 26 |
| 23. Ultra-Clear Mode..... | 26 |
| 24. Main Menu Options and Descriptions..... | 26 |
| 25. Warranty..... | 43 |
| 26. Basic Maintenance | 44 |
| 27. Basic Inspection | 45 |
| 28. General Troubleshooting | 45 |
| 30. Notes | 48 |

1. OVERVIEW

Based on the popular RICO Mk1 series, the RICO V2 was redesigned to have improved audio recording, a faster 60hz refresh rate, and increased sensitivity to an impressive <20mk. The heart of the RICO V2 features a high-performance InfiRay Micro II core and an extremely high-contrast AMOLED HD display. The RICO V2 takes its image processing one step further with Advanced Image Correction and Automatic Image Optimization courtesy of its MATRIX III processor. Unmatched image quality combined with an intuitive and easy-to-use interface, picture-in-picture function, 6+ hour run-time, aluminum alloy housing, 1000 G/s² shock-resistance, and 32 GB of internal memory, give you all the tools you need to take your hunt to the next level.

2. FEATURES

- 12 µm high-performance thermal detector
- High image quality
- High sensor sensitivity: NETD ≤20 mK
- Aluminum housing
- Maximum detection range 2400 yards
- Compatible with ILR-1000 Laser Rangefinder Module
- Two quick-change rechargeable battery packs
- HD 1024×768 AMOLED display
- High frame frequency: 60hz
- Multiple zero profiles and ranges
- Digital Zoom: ×1/×2/×3/×4
- Built-in 32 GB storage to support image capture and video recording
- Built-in Wi-Fi module
- Mobile device App compatible
- Built-in digital compass and motion sensor
- Multiple reticle types and color options
- Ultra-Clear mode for advanced image detail
- Picture in Picture (PIP)
- User-friendly interface
- Pixel calibration functions

3. TECH SPECS

| RICO | RH50 V2 |
|-------------------------------|---|
| SENSOR | |
| Resolution | 640×512 |
| Pixel Size | 12 µm |
| Frame Rate | 60hz |
| Sensor Sensitivity | ≤20 mK |
| Image Processing | MATRIX III |
| Core | InfiRay Micro II 640 |
| OPTICS | |
| Objective Lens | 50 mm f/1.0 |
| Magnification | 3× |
| Digital Zoom | 4× |
| Field of View | 8.8° × 6.6° |
| Detection Range | 2400 Yards |
| Display Type | AMOLED |
| Display Resolution | 1024×768 |
| Color Palettes | White Hot, Black Hot, Red Hot, Color, Violet, Crimson, Viridian |
| Reticle Types | 7 (2 Dynamic, 5 Static) |
| Reticle Colors | Black, White, Red, Green |
| Mounting System | Picatinny MIL-STD 1913 Rail |
| P.I.P. | Yes |
| Rangefinder | ILR-1000 Laser Rangefinder (Optional/Not Included) |
| Eye Relief | 55 mm |
| Diopter Range | -4 to +4 |
| ELECTRONICS | |
| Onboard Recording | Video and Image |
| Onboard Storage | 32 GB |
| Wireless Connectivity | Video and Image via App. |
| Data/Power Connector | USB-C |
| Power Supply | USB-C External, IBP-1 Li-ion Battery Pack ×2 (6+ Hours Each) |
| Start Up Time | <10 Seconds, Instant from Standby |
| PHYSICAL | |
| Size | 9.84" × 2.56" × 2.28" |
| Weight | 29.28 Oz |
| ENVIRONMENTAL/WARRANTY | |
| Warranty | 5 Years |
| Housing Material | Aluminum |
| Ingress Protection | IP67 |
| Operation Temperature | -4°F~122°F |
| Max. Recoil | 300 Win./7mm Mag |

4. ACCESSORIES

The RICO V2 rifle scope ships with everything you need to get out and hunt.

- 50mm Objective Lens Cap
- Standard Rubber Eyeguard
- Dual-throw Mount
- M5 Screws for Mount
- Spanner/T15 Tool
- USB-C to Analog RCA/USB Cable 36"
- IBP-1 Battery 4400 mAh
- IBC-1 Battery Charger
- USB Power Adapter
- Storage Bag
- Lens Cloth
- User Manual



Optional accessories, such as the IRAY-AC05 ILR-1000 Laser Rangefinder Module, as well as various replacement accessories, including cables and factory mounts are available for purchase. Contact 800-769-7125 or irayusa.com/support.

5. COMPONENTS AND CONTROLS

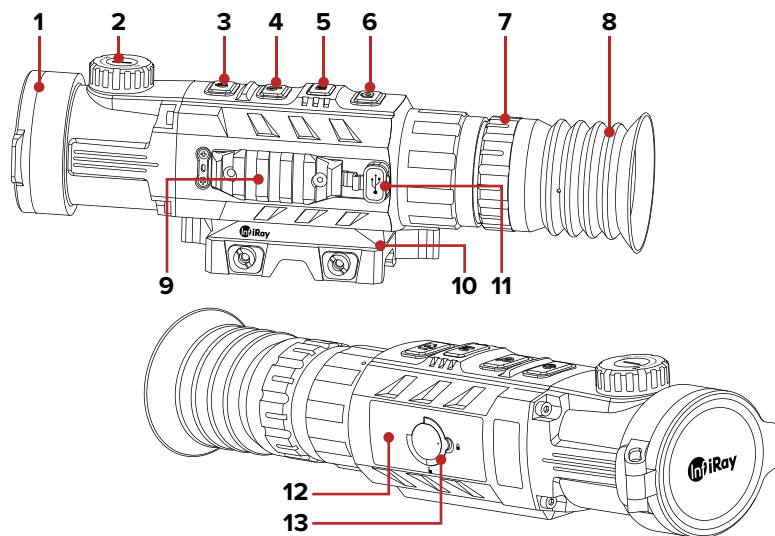

- 1 Objective Lens Cap
- 2 Objective Lens Focus Knob
- 3 Power Button
- 4 Zoom Button
- 5 Menu Button
- 6 Photo Button
- 7 Eyepiece / Diopter Adjustment Ring
- 8 Eyeguard
- 9 Accessory Rail for ILR-1000 Laser Rangefinder Module (optional / not included)
- 10 Dual-throw Mount
- 11 USB-C Port
- 12 IBP-1 Battery Pack
- 13 Battery Pack Pull Ring



6. DESCRIPTION OF CONTROL BUTTONS AND SHORTCUTS

| Power Button  | | |
|--|--|----------------------|
| Current Screen, Menu, or Device Status | Short Press | Long Press |
| Device off | --- | Power on the device |
| Home screen | Perform a non-uniformity correction (NUC) | Power off the device |
| In standby mode | Exit standby | --- |
| Main menu | Exit the menu without saving changes | --- |
| Reticle zeroing interface | Exit the interface without saving the new reticle position | --- |

| Power + Zoom Button  +  | | |
|---|----------------------|------------|
| Current Screen / Menu | Short Press | Long Press |
| Home screen | Enter / exit standby | --- |



| Zoom / Up Button  | | |
|--|---|---|
| Current Screen / Menu | Short Press | Long Press |
| Home screen | Adjust digital zoom | Turn PIP window on / off |
| Main menu / quick menu | Move the cursor up | --- |
| Reticle zeroing interface | Move the cursor 1 pixel in the positive direction | Move the cursor 10 pixels in the positive direction |

NOTE: Consult the manual that comes with your ILR-1000 Laser Rangefinder Module (optional/not included) for rangefinder shortcuts.

| Zoom + Photo Button  +  | | |
|---|-------------|--|
| Current Screen / Menu | Short Press | Long Press |
| Reticle zeroing interface | --- | Freeze image to keep reticle centered on aiming point; press again to clear frozen image |

| Menu Button  | | |
|---|--|------------------------------------|
| Current Screen / Menu | Short Press | Long Press |
| Home screen | Enter the quick menu | Enter the main menu |
| Main menu | Change menu options; enter the submenu; confirm submenu changes and return | Save and return to the home screen |
| Quick menu | Toggle through the menu options | Exit the quick menu |
| Reticle zeroing interface | Select / deselect the axis of movement (X or Y) | Save the new reticle position |

| Photo / Down Button  | | |
|---|---|---|
| Current Screen / Menu | Short Press | Long Press |
| Home screen | Take a photo | Start / stop recording video |
| Quick menu / main menu | Move the cursor down | --- |
| Reticle zeroing interface | Move the cursor 1 pixel in the negative direction | Move the cursor 10 pixels in the negative direction |

| Zoom + Menu + Photo Button  +  +  | | |
|--|-------------|---|
| Current Screen / Menu | Short Press | Long Press |
| Home screen | --- | Activate / deactivate the reticle (Long press for 15 seconds) |

7. QUICK START GUIDE

Step 1: Prepare to Use the RICO V2

1. Compare the box contents to the accessories list and examine each for any shipping damage. See **Accessories** on page 4.
2. Check the lens to ensure there are no smudges or dirt present. Clean with the included lens cloth as needed.
3. Charge the battery pack **(12)** using the included battery pack charger **(14)** before using the RICO V2 for the first time. See **Charging the Battery Pack** on page 10.
4. Insert the battery pack into the battery compartment. See **Installing the Battery Pack** on page 11.
5. Install the eyeguard **(8)**.
6. Mount the RICO V2 to the weapon. See **Mounting the RICO V2** on page 13.

Step 2: Turn On the RICO V2

1. Open the objective lens cap **(1)**.
2. Long press the **Power**  button for 3 seconds to power on the RICO V2. The iRayUSA logo will appear.
3. Rotate the diopter adjustment ring **(7)** of the eyepiece until the interface icons are clear.

WARNING: Do not point the objective lens toward intense energy sources, such as the sun. This may render the electronic components inoperative. The warranty does not cover damage caused by improper operation.

Step 3: Adjust Image Settings in the Quick Menu

Short press the **Menu**  Button to enter the quick menu to adjust the following settings (see **Using the Quick Menu** on page 18):



1. Set the color palette to white hot, black hot, red hot, color, violet, crimson, or viridian.
2. Set the display brightness level from 1–5.
3. Set the image sharpness level from 1–10.
4. Set the image brightness level from 1–10.
5. Set the image contrast level from 1–10.

Step 4: Adjust Device Settings in the Main Menu



Long press the **Menu**  Button to enter the main menu to adjust the following settings:

1. Set the desired non-uniformity correction (NUC) mode to automatic, manual, or background. See **Non-Uniformity Correction** on page 21.
2. Turn on the digital compass.
3. Turn on the motion sensor.
4. Set the image hue to warm or cool.
5. Turn on the microphone.
6. Calibrate the digital compass.
7. Set the date and time.
8. Set the units of measure to meters or yards.

Step 5: Adjust Digital Zoom and PIP Settings

1. From the home screen, short press the **Zoom**  Button to set the digital zoom level to 1×, 2×, 3×, or 4×.
2. From the home screen, long press the **Zoom**  Button to turn on the PIP window. A 2× zoomed image (2× that of the total zoom shown in the status bar) appears at the top of the screen.

Step 6: Set Up the Reticle and Zero the RICO V2

1. The reticle may be inactive when the RICO V2 is powered on for the first time. To activate the reticle, press and hold the **Zoom** , **Menu** , and **Photo**  Buttons at the same time for at least 15 seconds from the home screen.
2. Set the zeroing profile and reticle options in the main menu:
 - a. Set the zeroing profile to A, B, or C.
 - b. Select a reticle type from 1–7. A custom reticle is also available in the App.
 - c. Set the reticle color to white, black, red, or green.
3. Zero the rifle scope. See **Zeroing the RICO V2** on page 20.
 - a. Select, or customize, a preset zero distance that matches the target distance.
 - b. Zero the reticle.

See **Main Menu Options and Descriptions** on page 26 for main menu information and detailed instructions.

8. CHARGING THE BATTERY PACK

The RICO V2 rifle scope comes with two IBP-1 long-lasting rechargeable lithium-ion battery packs, which allow for 6+ hours of operation each. The IBP-1 uses a cam-locking mechanism to ensure quick and secure battery changes in the field. Fully charge the battery packs before using the RICO V2 for the first time.

Charging with the Battery Charger

1. Insert the battery pack (12) into the battery charger (14). Align the slots (A) on the edge of the battery pack with the pins (B) on the inside of the charger.
2. Connect the USB-C end of the data cable (15) to the USB-C port (C) on the battery pack charger.
3. Connect the USB end of the data cable to:
 - a. The included 5V–2A USB power adapter; **OR**
 - b. Any standard USB 3.0 port on a laptop or computer.

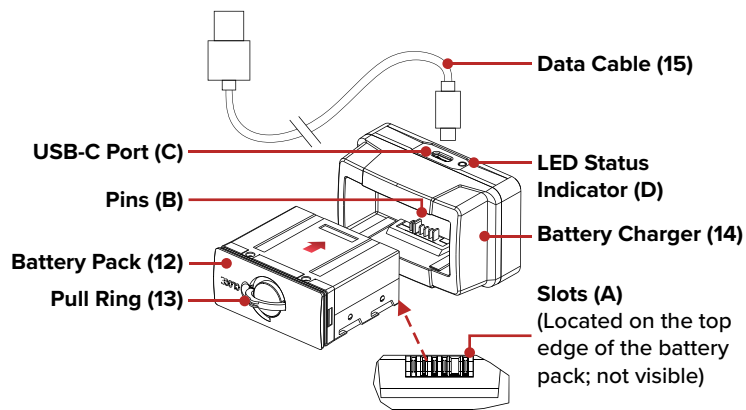

4. During charging, the LED indicator (D) on the battery pack charger will be solid red.
5. When fully charged, remove the battery pack from the battery charger. Do not overcharge. The LED indicator will turn solid green when the battery is fully charged.



NOTE: When the LED indicator flashes red, the battery charger is connected to a power source but no battery pack is installed.

WARNING: Never use the battery charger with a USB power adapter that is greater than 5V–2A.

Charging via the USB-C Port

1. Connect the USB-C end of the data cable to the USB-C port (11) on the side of the RICO V2.
2. Connect the standard USB end of the data cable to:
 - a. The included 5V–2A USB power adapter; **OR**
 - b. Any USB 3.0 port on a laptop or computer; **OR**
 - c. An external power supply, such as a USB power bank.

NOTES:

- You may charge and operate the RICO V2 at the same time.
- When the battery status icon in the status bar at the top of the screen becomes the low battery  icon, charge the battery right away to avoid over-discharge and a reduction in battery capacity or service life.
- While charging, the battery status icon shown in the status bar will change to the charging  icon.

9. INSTALLING THE BATTERY PACK

1. Lift the pull ring (13) on the battery pack (12) and rotate it clockwise 90 degrees until it is horizontal to the battery pack.
2. Position the battery pack face up with the slots (A) facing up.
3. Align the slots (A) on the top edge of the battery pack with the pins (B) on the inside of the battery compartment, then slide the battery pack into the opening.

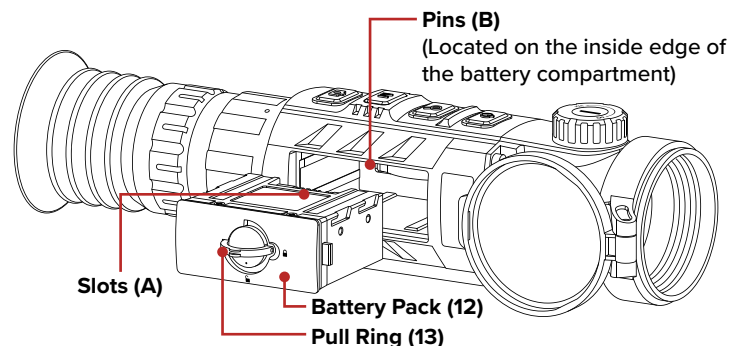

4. Insert the battery. Press in firmly to fully seat it.
5. Rotate the pull ring counterclockwise 90 degrees to the vertical position to lock the battery pack in place.
6. Flip the pull ring down so that it is flush with the battery pack.

WARNING: The RICO V2 can only be powered by a factory-supplied IBP-1 battery pack. Using any other battery pack may cause irreparable damage to the device or cause a fire. Any damage from using an improper battery pack will not be covered by warranty.

10. REMOVING THE BATTERY PACK

To remove the battery pack from the RICO V2:

1. Lift the pull ring on the battery pack and rotate it clockwise 90 degrees until it is horizontal to the battery pack.
2. Pull the battery pack out.

11. BATTERY SAFETY WARNINGS

WARNING: Only use the battery charger (14) supplied with the battery pack. The use of any other charger may irreparably damage the battery pack or the charger and may cause a fire. Any damage from using an improper battery charger will not be covered by warranty.

WARNINGS:

- Do not use a battery charger, power adapter, or USB cable that has been modified or damaged.
- Do not expose the battery to high temperatures or flames, and do not immerse in water.
- Do not leave the battery unattended while charging.
- Do not leave the battery charging for long periods after full charge is reached. Charging time should not exceed 24 hours.
- Keep the battery pack out of the reach of children and pets.
- The battery is equipped with short-circuit protection. However, any situation that may cause short-circuiting should be avoided.
- Do not disassemble, modify, hit, or drop the battery pack.
- Do not connect the battery to any external device with an electrical current that exceeds permitted levels.
- Do not connect an external device with a current supply that exceeds a 3.0 USB port.

To maintain optimal battery capacity and service life:

- Avoid storing a fully charged or discharged battery for long periods. Partial charging of the battery is necessary if the battery will be stored for an extended period.
- Do not charge an extremely cold battery without first allowing it to warm up in a room temperature environment. Let the battery warm up for 45 minutes before charging.
- Charge the battery at a temperature range from 32°F to 113°F; otherwise, the service life of the battery may be reduced.
- The recommended operating temperature range is -4°F to 122°F. Avoid using the battery above the maximum or below the minimum recommended temperature range as this may decrease the battery capacity or service life.

12. EXTERNAL POWER SUPPLY

The RICO V2 supports the use of an external power supply, such as a 5V mobile power bank.

1. Connect the external power supply to the USB-C port (11).
2. The RICO V2 will switch to operation from the external power supply, and the battery pack will begin slowly charging.
3. The battery status icon in the status bar will change to a charging battery  icon, with the battery color and fill level indicating the current charge level. See **Battery Status** on page 18 for additional information.
4. If the external power supply is disconnected, the RICO V2 will automatically switch to the battery pack without powering off.

NOTE: Do not connect the RICO V2 to an external device with a power supply that exceeds the 3.0 USB cable.

13. MOUNTING THE RICO V2

Installing the Dual-Throw Mount

Before using the RICO V2, install the dual-throw mount to the base of the rifle scope.

1. Install the dual-throw mount (10) to the three mounting holes in the base of the RICO V2 using a 3mm hex key and the included M5 screws (16) supplied in the package.

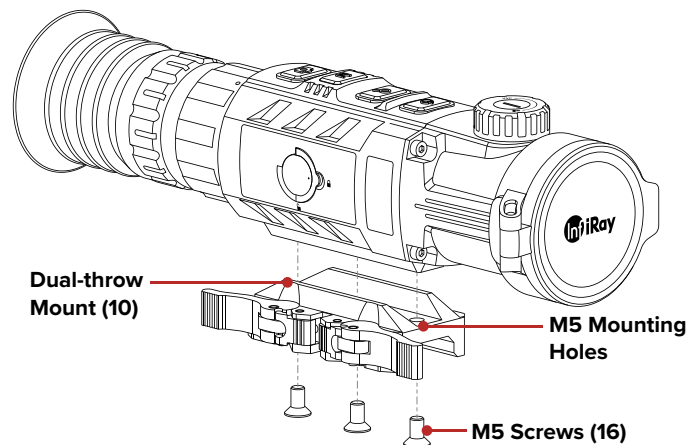

2. Install the RICO V2 to the rifle and adjust its position so that it produces a clear image and is comfortable for the shooter.
3. When the location is suitable, remove the M5 screws one at a time and apply a small amount of blue Locktite 242 to the threads.
4. Reinsert each screw and tighten to 20 in/lbs with a torque wrench.

5. Allow the threadlocker to dry.

NOTE: Please note, the torque is inch-pounds, NOT foot-pounds. If you do not have a torque wrench, apply until snug. Do not overtighten.

When the threadlocker is dry, install the mount and rifle scope to the Picatinny rail of your rifle.

6. Press the locking button (17) and then pull each throw lever (18) forward to open it.
7. Install the mount to the Picatinny rail.

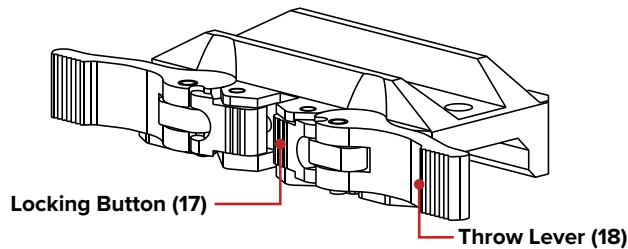

8. Press the throw levers closed to lock the mount in place. You will hear the levers and locking buttons click into place.

The RICO V2 is now ready to be zeroed. See **Zeroing the RICO V2** on page 20 for instructions.

Adjusting the Tension of the Throw Levers

If you cannot slide the mount onto the Picatinny rail because the throw levers are in the open position but the locking plate is not, or if the mount is not tight to the rail after the throw levers are closed, you may loosen or tighten the tension of the throw levers (18) by adjusting the nuts (19).

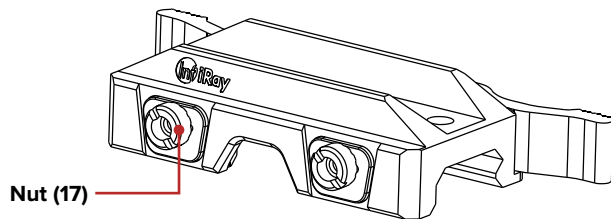

1. Open both throw levers (18). This will cause the adjustment nuts (19) to protrude on the opposite side of the mount.
2. Use the included spanner tool to turn both adjustment nuts clockwise to tighten, or counterclockwise to loosen, to achieve the correct amount of tension. You should not feel any tension on the throw lever when closing until it reaches a 45-degree angle. Do not overtighten.

14. OPERATING INSTRUCTIONS

WARNING!

Don't point the objective lens towards any intense energy sources, such as laser radiation or the sun. This may render the electronic components inoperative. The warranty does not cover damage caused by improper operation.

Using the Control Buttons

The RICO V2 is operated via four control buttons. The control buttons can be used to perform shortcut operations from the home screen, as well as in the menu and full-screen interfaces. See **Description of Control Buttons and Shortcuts** on page 6 for shortcut button details.



Powering On

1. Open the objective lens cap (1).
2. Long press the **Power**  button for 3 seconds to turn on the rifle scope. The iRayUSA logo will appear.



To determine the current battery charge, check the battery icon in the status bar at the top of the viewscreen. See **Battery Status** on page 18.

Powering Off and Entering Standby Mode

To power off the RICO V2:

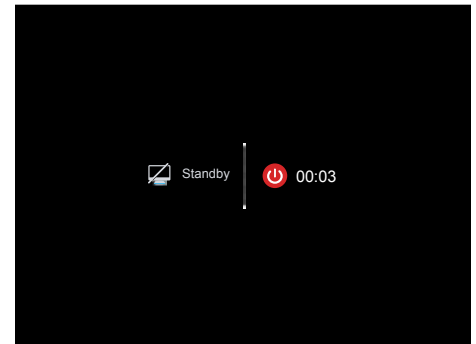
1. Long press the **Power**  button. The standby screen will open, showing a 3-second countdown.
2. Continue holding the **Power**  button until the countdown completes.
3. "Saving..." appears onscreen and the RICO V2 will shut down automatically after saving.



NOTE: Releasing the **Power**  Button at any time before the countdown reaches zero will stop the shutdown process and the rifle scope will enter standby mode. Short press the **Power**  Button to exit standby.



WARNING: If using an external power supply, do not remove the power supply when saving data, otherwise the data may not be saved.

ENTERING STANDBY MODE

Standby mode may be activated to conserve battery life.

Manually Enter Standby Mode

The user may enter standby mode manually at any time.

1. To enter standby from the home screen, short press the **Power**  and **Zoom**  **Buttons** at the same time.
2. Short press the **Power**  **Button** to exit standby.

Set the RICO V2 to Enter Standby Mode Automatically

The rifle scope may be set to automatically enter standby mode after 3 seconds of inactivity.

1. Turn on auto standby mode in the main menu. When on, the RICO V2 will automatically enter standby after 3 seconds of inactivity.
2. Short press the **Power**  **Button** to exit standby.

NOTES:

- When auto standby mode is turned on in the menu:
 - The RICO V2 will enter standby automatically when it is tilted up or down at an angle of more than 70° or left or right at an angle of more than 30°.
 - The RICO V2 will not enter standby mode while it is in a level firing position.
- When auto standby is turned off, the rifle scope will operate until the batteries run out.
- See **Main Menu > Standby** on page 36 for instructions.

Adjusting the Focus

ADJUSTING THE DIOPTER/EYEPIECE

1. Rotate the eyepiece diopter adjustment ring **(7)** at the rear of the rifle scope right or left until the user interface is clear.
2. Look closely to ensure all screen icons, the status bar, and the reticle appear sharp and in focus.

NOTES:

- After the initial adjustment, there is no need to rotate the diopter adjustment ring **(7)** for long distances or other conditions.
- If necessary during standard use, you may rotate the objective lens focus knob **(2)** to adjust fine focus on the target object being observed. See **Focusing the Objective Lens** on the next page.

FOCUSING THE OBJECTIVE LENS



To adjust the focus on the target object:

1. Rotate the objective lens focus knob **(2)** left or right.

NOTE: Re-adjusting the focus will be necessary if the distance to your target changes.

Activate / Deactivate the Reticle















The reticle may be inactive when the RICO V2 is powered on for the first time. To activate the reticle, or to deactivate it at a later time:

1. From the home screen, press and hold the **Zoom** , **Menu** , and **Photo**  **Buttons** at the same time for at least 15 seconds.

Status Bar Overview





The status bar at the top of the screen shows information on the operating status of the RICO V2:



- 1 Color Palette:** Shows the selected color palette: white hot , black hot , red hot , color , violet , crimson , or viridian .
- 2 Zeroing Profile & Distance:** Shows the selected zero profile, A, B, or C, and the zero distance.
- 3 Ultra-Clear Mode:** Shows the Ultra-Clear status: on  or off . Ultra-Clear mode is off by default.
- 4 Magnification:** Shows the current total magnification.
- 5 Non-Uniformity Correction (NUC) Mode:** Shows the non-uniformity correction (NUC)  icon and selected mode: automatic (A), manual (M), and background (B). A countdown timer will appear instead of the calibration mode when 5 seconds remain until an automatic NUC.
- 6 Video Output:** Shows the video output  icon when on. Video Output is off by default.
- 7 Microphone:** Shows the microphone status: on  or off . The microphone is off by default.
- 8 Wi-Fi:** Shows the Wi-Fi status: on  or off . Wi-Fi is off by default.
- 9 Time:** Shows the current time in 24-hour format.
- 10 Battery:** Shows the current battery status.

BATTERY STATUS









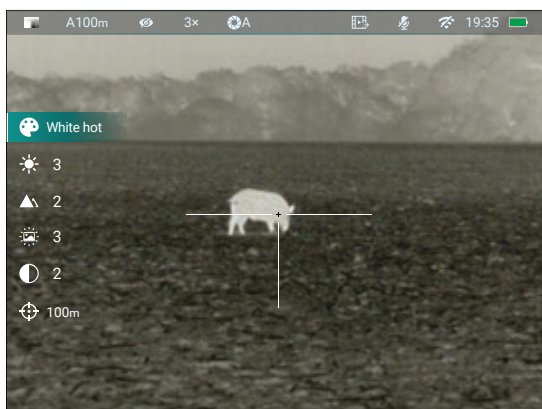





The battery icon color and fill level indicate the current battery status. The battery icon is replaced by the charging battery icon when an external power supply is connected.



| COLOR / ICON | BATTERY STATUS |
|--|---|
| Green Battery  | 41% – 100% |
| Yellow Battery  | 20% – 40% |
| Red Battery  | <20%; charge the battery pack right away. |
| Charging Battery  | The battery pack is charging; an external power supply or computer is connected via the data cable. |

Using the Quick Menu

In the quick menu, the color palette, display brightness, image sharpness, image brightness, image contrast, and zero distance may quickly be adjusted.







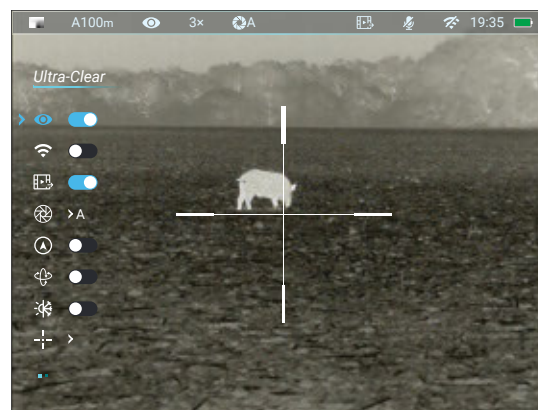

- On the home screen, short press the **Menu**  Button to enter the quick menu.
- Press the **Up / Zoom**  Button or **Down / Photo**  Button to move through the menu options below. The selected menu item is highlighted in the background.
 - **Color Palette:** Short press the **Menu**  Button to set the color palette to white hot , black hot , red hot , color , violet , crimson , or viridian . The selected color palette appears in the status bar.
 - **Display Brightness:** Short press the **Menu**  Button to change the display brightness level from 1–5.
 - **Image Sharpness:** Short press the **Menu**  Button to change the image sharpness level from 1–10.
 - **Image Brightness:** Short press the **Menu**  Button to change the image brightness level from 1–10.

- **Image Contrast:** Short press the **Menu**  Button to change the image contrast level from 1–10.
- **Zero Distance:** Short press the **Menu**  Button to select a new zero distance within the selected zeroing profile. Only the zero distances in the selected profile will be available. The selected zeroing profile and distance appear in the status bar.
- Long press the **Menu**  Button to confirm any changes and return to the home screen.

NOTE: In the quick menu, if there is no user input for 5 seconds, the RICO V2 will automatically save any changes and return to the home screen.

Navigating the Main Menu











- From the home screen, long press the **Menu**  Button to enter the main menu.
- Short press the **Up / Zoom**  Button or **Down / Photo**  Button to move up and down through the menu options.
- A blue arrow indicates the cursor position in the menu.
- Short press the **Menu**  Button to:
 - Change the parameters for the selected menu option; **OR**
 - Enter the submenu; **OR**
 - Confirm submenu changes and return to the previous menu.
- Long press the **Menu**  Button to confirm any changes and return to the home screen.
- Short press the **Power**  Button to return to the previous menu without saving.
- After 15 seconds of inactivity, the menu will automatically close and the interface will return to the home screen. Changes (except changes to toggle on / off menu items, such as Ultra-Clear and Wi-Fi) are not saved automatically.

- Upon exiting from the main menu the cursor location is stored for a single working session (until the RICO V2 is turned off). After restarting the RICO V2 and entering the menu, the cursor position will be at the first menu item.

15. ZEROING THE RICO V2

The RICO V2 features a freeze zeroing method.

To zero the RICO V2:

1. Set a suitable target at the desired zero distance.
2. Confirm that the rifle is empty, safe, and pointed in a safe direction, with no ammunition near the weapon.
3. Adjust the image and device settings following the steps in the Quick Start Guide on page 8, if you have not done so already.
4. Select the zeroing profile, A, B, or C. See **Reticle Menu > Zeroing Profile** on page 31.
5. Based on the distance to the target you wish to zero, select a preset zero distance OR customize one of the preset zero distances to match. The RICO V2 supports custom zeroing distances of 1 to 999 meters or 1 to 999 yards. See **Main Menu > Zeroing** on page 32.
6. Ensure a stable platform and natural shooting position is achieved behind the rifle.
7. Load ammunition, aim, and take one good shot at the target.
8. Make your rifle safe and observe the location of impact on the target.
9. If the point of impact does not match the point of aim (the center of the reticle), adjust the X/Y position of the reticle.
10. In the submenu for the selected zero distance, center the reticle on the aiming point and long press the **Zoom**  **Button** and **Photo**  **Buttons** at the same time to freeze the image. The image freeze  icon will appear below the X/Y coordinates.
11. Select the axis (X or Y) along which to move the reticle:
 - a. Short press the **Up**  or **Down**  **Button** to move between **X** and **Y**. The cursor position is indicated by a blue arrow and blue font. X is selected by default
 - b. Short press the **Menu**  **Button** to select X or Y. The selected axis will flash continuously.
12. Adjust the X/Y position of the reticle until the reticle matches the point of impact:
 - a. Use the **Up**  **Button** to move in the positive direction: X= Right and Y= Up.
 - b. Use the **Down**  **Button** to move in the negative direction: X= Left and Y= Down.

- c. Upon moving the reticle, a white dot appears onscreen, representing the original position of the reticle.

13. Long press the **Menu**  **Button** to save the reticle position.

14. Take a confirmation shot—the point of impact should now match the point of aim. If not, adjust the X/Y position of the reticle again.

For detailed Zeroing instructions, please see **Zeroing Menu > Reticle Zeroing** on page 33.

16. NON-UNIFORMITY CORRECTION

A non-uniformity correction (NUC) allows a thermal imager's sensors to correct its pixels and eliminate any image defects caused by pixel drift. A NUC will be performed automatically each time the RICO V2 is powered on.

The RICO V2 has three NUC modes, automatic (A), manual (M), and background (B). The selected NUC mode (A, M, or B) appears in the status bar. For instructions on setting the NUC mode, see **Main Menu > Calibration** on page 28.

Automatic Mode

In automatic mode (A), the RICO V2 will perform a NUC automatically according to the internal software algorithm. There is no need to close the objective lens cap **(1)** as the RICO V2's internal shutter covers the sensor.

A countdown timer will appear in the status bar instead of the calibration mode when 5 seconds remain until an automatic NUC is performed. Pressing the **Power**  **Button** during the 5-second countdown will cancel the pending NUC. The timer will appear only after the microbolometer temperature has stabilized—after approximately 10 minutes of continuous operation of the RICO V2.

NOTE: A manual NUC (see below) may be performed at any time while in Automatic (A) mode.

Manual Mode

In manual mode (M), the user independently determines the need to perform a NUC based on the quality of the observed image. It is not necessary to close the objective lens cap **(1)** during a manual NUC, as the internal shutter covers the sensor.

To perform a manual NUC while in manual mode (or automatic mode):

1. From the home screen, short press the **Power**  **Button**.
2. A manual NUC is performed instantly.

Background Mode

In background mode (B), the user independently determines the need to perform a background NUC based on the quality of the observed image. A background NUC uses less power than an automatic or manual NUC because it does not use the imager shutter to cover the sensor; instead, the user must close the lens cap.

To perform a background NUC while in background mode:

1. Close the objective lens cap (1).
2. From the home screen, short press the **Power**  **Button**.
3. A prompt to close the lens cap appears onscreen. The background NUC starts after about 2 seconds.

NOTE: If the lens is not properly covered, a temporary “image burn” will remain in the image until the next non-uniformity correction. This “image burn” is temporary and is not a defect or sign of permanent damage.



17. PHOTOGRAPHY AND VIDEO RECORDING

The RICO V2 is equipped with video recording and image capture. All videos and photos are automatically saved to the RICO V2's built-in 32 GB memory storage.

NOTE: Photo and video files are named with the time and date; therefore, it is recommended to set the date and time before using the photo and video functions. See **Settings Menu > Date** and **Settings Menu > Time** on page 39. Alternatively, the date and time may be synchronized in the InfiRay Outdoor App.

Photography

To take a photo:





1. From the home screen, short press the **Photo**  **Button**.
2. The image will freeze for 0.5 seconds and the camera  icon will appear in the upper-left corner of the screen.



NOTE: A red warning icon  appears next to the camera icon in the upper-left corner of the screen when insufficient memory storage is available. Transfer video and image files to other storage media to free up space on the memory card.

Video Recording

To record video:

1. Turn on the microphone in the main menu.
2. From the home screen, long press the **Photo**  **Button** to start a video recording.
3. When the video recording starts, the video  icon and the video recording timer, in HH:MM:SS (hour/minute/second) format, appear in the upper-left corner of the screen.
4. When recording, short press the **Photo**  **Button** to take a photo.
5. Long press the **Photo**  **Button** to stop and save the video recording.



Video and Photography Notes

- You may enter and navigate the menu during video recording.
- The user interface (status bar and menu) is captured in recorded photos and video.
- Recorded photos and videos are saved to the internal memory:
 - Photos are saved in PIC_HHMMSS.jpg format.
 - Videos are saved in VIDEO_HHMMSS.mp4 format.
 - HHMMSS is hour/minute/second. XXX is a 3-digit counter number. The counter used for multimedia file names cannot be reset. If a file is deleted from the internal memory, its counter number is not taken by another file.
- The maximum duration of a recorded video file is 5 minutes. After this time, video recording will begin a new file automatically.
- The number of recorded files is limited only by the capacity of the internal memory.
- Check the available space on the internal storage card regularly and move video footage and images to other storage media to free up space on the memory card.

18. ACCESSING THE INTERNAL MEMORY

When the RICO V2 is turned on and connected to a computer via the included data cable, it is recognized by the computer as a flash memory (USB) drive. This allows the user to access the saved multimedia files and copy or delete any desired files.

To access the internal memory:

1. Turn on the RICO V2.
2. Connect the USB-C end of the data cable to the USB-C port **(11)**.
3. Connect the USB end of the data cable to your computer.
4. Double-click **My Computer** on your computer desktop.
5. Double-click the device named **RH50V2** to open it.
6. Double-click the device named **Internal Storage** to access the built-in memory.
 - a. The device shows the available space (in GB) remaining of the 32 GB of total memory storage.
 - b. Recorded photos and videos are separated by date into folders named by date, YYYYMMDD (year/month/day).
7. Select the desired files or folders to copy or delete.

19. VIDEO OUTPUT

The video output function enables connectivity with an external display or recording device via analog video.

To output video:

1. Turn on the RICO V2.
2. Connect the USB-C end of the data cable to the USB-C port **(11)**.
3. In the main menu, turn on video output. See **Main Menu > Video Output** on page 28 for instructions.
4. When video output is on, the video output  icon appears in the status bar.
5. Connect the RCA connector to the RCA port on the external display or recording/display device.

20. USING THE INFIRAY OUTDOOR APP

The RICO V2 can be operated using the InfiRay Outdoor App when the thermal imager is connected to a smartphone or tablet via Wi-Fi.



1. Download the App for free and install it on your smartphone or tablet:
 - a. Scan one of the QR codes above to download the InfiRay Outdoor App from the App Store or Google Play; **OR**
 - b. Download the App from any app store.
2. Connect the RICO V2 to Wi-Fi:
 - a. In the main menu, turn on Wi-Fi. See **Main Menu > Wi-Fi** on page 27 for instructions.
 - b. Open the App and press the **ViewFinder**  icon on the home screen.
 - c. Click the **Connect Device WiFi** button.
 - d. On the mobile device, go to **Settings > Wi-Fi**.
 - e. Select the RICO V2 from the list of Wi-Fi networks. It will appear in the list as “RH50V2_YYYYY_YYYYYYYY”, where YYYYY_YYYYYYYY is the thirteen-digit device serial number.
 - f. Enter the Wi-Fi password and tap the **Join** button. The default password is 12345678.
3. Operate the RICO V2 via the App:
 - a. Take real-time photos and videos, with or without audio.
 - b. View, share, download, and delete photos and videos taken via the App, which are saved to the mobile device.
 - c. Change the Wi-Fi password and SSID.
 - d. Synchronize the date and time from the mobile device.
 - e. Update the RICO V2’s firmware.

NOTE: When a factory reset is performed, the Wi-Fi SSID and password are reset to the defaults, RH50V2_YYYYY_YYYYYYYY and 12345678. See **Settings Menu > Factory Reset** on page 41.

21. DIGITAL ZOOM

The RICO V2 will quickly increase the base magnification by enlarging the image from 1 to 4 times digitally.

To adjust the digital zoom:

1. From the home screen, short press the **Zoom**  **Button** to adjust the digital zoom level to 1×, 2×, 3×, or 4×. The total magnification is displayed in the status bar.

22. PICTURE IN PICTURE (PIP)

The Picture in Picture (PIP) function opens a small floating window with a magnified image view at the top of the screen. PIP allows for improved aiming while still being able to see the wide field of view in the main body of the screen.

To turn the Picture in Picture window on / off:

1. From the home screen, long press the **Zoom**  **Button**. A 2× zoomed image, centered on the reticle, will appear at the top of the screen. Please note that the PIP image is 2× that of the total magnification shown in the status bar.

NOTE: When the image in the main body of the screen is magnified via digital zoom, the PIP image will enlarge accordingly.

23. ULTRA-CLEAR MODE

Ultra-Clear mode improves the image quality in inclement weather conditions, such as rain, fog, high humidity, or high temperatures as these conditions all result in lower thermal contrast. Ultra-Clear mode enhances the NETD value of the thermal sensor and improves the sensor's response rate to these challenging environment conditions. See **Main Menu > Ultra-Clear** on the next page.

Ultra-Clear mode provides:

- Improved image quality and clarity; images are crisper and sharper.
- Increased image detail.
- Improved recognition of observed targets.

24. MAIN MENU OPTIONS AND DESCRIPTIONS

Menu and submenu options, from top to bottom are:

- **Main Menu:** Ultra-Clear, Wi-Fi, Video Output, Calibration, Compass, Motion Sensor, Image Hue, Reticle, Zeroing, Microphone, Standby, Laser Calibration, Pixel Defect Correction, Compass Calibration, Settings.









- **Reticle Menu:** Zeroing Profile, Reticle Type, Reticle Color.
- **Zeroing Menu:** Three zero distance options.
 - **Zeroing Distance Submenu:** Reticle Zeroing, Custom Zero Distance.
- **Settings Menu:** Date, Time, Languages, Unit, Status Bar, Factory Reset, Info.

Menu option details, descriptions, and navigation instructions are listed in order on the following pages.

Ultra-Clear

Turn Ultra-Clear mode on / off

When Ultra-Clear mode is turned on, the image contrast is enhanced, which is suitable for rainy, foggy, or low-contrast conditions.

1. Long press the **Menu**  **Button** to enter the main menu.
2. Short press the **Up**  or **Down**  **Button** to select the Ultra-Clear  menu item.
3. Short press the **Menu**  **Button** to toggle Ultra-Clear on / off. The Ultra-Clear status, on  or off , appears in the status bar.
4. Long press the **Menu**  **Button** to return to the home screen.



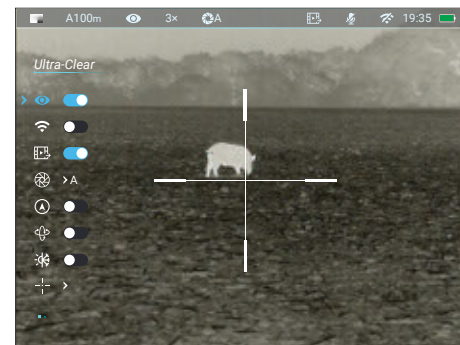





NOTE: When Ultra-Clear mode is turned on and off, the RICO V2 will automatically perform a shuttered non-uniformity correction.



Wi-Fi

Turn Wi-Fi on / off

Turn on Wi-Fi to manipulate the RICO V2 via the InfiRay Outdoor App.



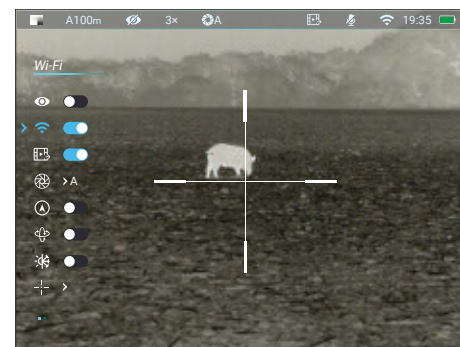



1. Long press the **Menu**  **Button** to enter the main menu.
2. Short press the **Up**  or **Down**  **Button** to select the Wi-Fi  menu item.
3. Short press the **Menu**  **Button** to toggle Wi-Fi on / off. The Wi-Fi status, on  or off , appears in the status bar.
4. Long press the **Menu**  **Button** to return to the home screen.



Video Output

Turn video output on / off

The video output function enables connectivity with an external display or recording device via analog video.



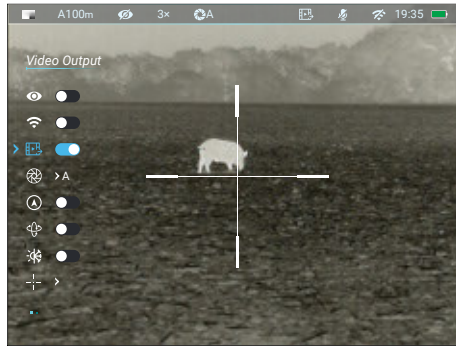





1. Long press the **Menu**  **Button** to enter the main menu.
2. Short press the **Up**  or **Down**  **Button** to select the video output  menu item.
3. Short press the **Menu**  **Button** to toggle video output on / off. When video output is on, its icon  appears in the status bar.
4. Long press the **Menu**  **Button** to return to the home screen.



Calibration

Set the non-uniformity correction mode





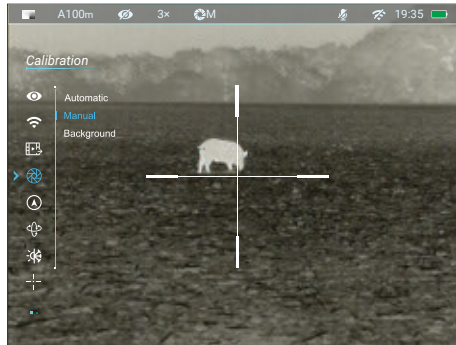

The RICO V2 has three non-uniformity correction (NUC) modes, Automatic (A), Manual (M), and Background (B).

1. Long press the **Menu**  **Button** to enter the main menu.
2. Short press the **Up**  or **Down**  **Button** to select the calibration  menu item.
3. Short press the **Menu**  **Button** to enter the submenu.
4. Short press the **Up**  or **Down**  **Button** to move through the options, Automatic (A), Manual (M), and Background (B). The selected NUC mode, A, M, or B, appears in the status bar.
5. Long press the **Menu**  **Button** to confirm the selection and return to the home screen.



Compass





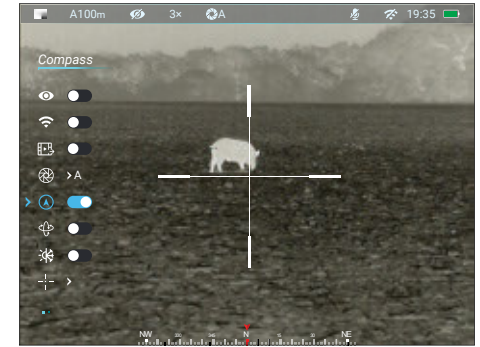

Turn the digital compass on / off

1. Long press the **Menu**  **Button** to enter the main menu.
2. Short press the **Up**  or **Down**  **Button** to select the compass  menu item.
3. Short press the **Menu**  **Button** to toggle the digital compass on / off. When the compass is on, it appears at the bottom of the screen.
4. Long press the **Menu**  **Button** to return to the home screen.



Motion Sensor

Turn the motion sensor on / off

1. Long press the **Menu**  **Button** to enter the main menu.
2. Short press the **Up**  or **Down**  **Button** to select the motion sensor  menu item.
3. Short press the **Menu**  **Button** to toggle the motion sensor on / off. When the motion sensor is on, the tilt angle appears on the left side of the screen and the pitch angle appears on the right side of the screen.
4. Long press the **Menu**  **Button** to return to the home screen.

NOTE: The tilt angle is not shown in the figure above because it is hidden by the menu.

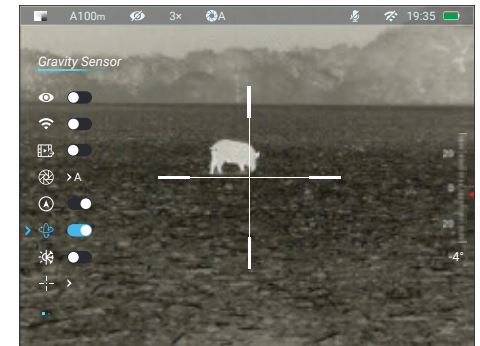







Image Hue

Toggle between warm and cool image hue modes





1. Long press the **Menu**  **Button** to enter the main menu.
2. Short press the **Up**  or **Down**  **Button** to select the image hue  menu item.
3. Short press the **Menu**  **Button** to toggle between warm and cool image hue. When the toggle is on, cool is selected. When the toggle is off, warm is selected.
4. Long press the **Menu**  **Button** to confirm the selection and return to the home screen.

NOTES:

- Cool mode provides a brighter image and warm mode provides a softer image and reduces eye strain.
- The red hot, color, violet, crimson, and viridian color palettes do not support image hue.

Reticle





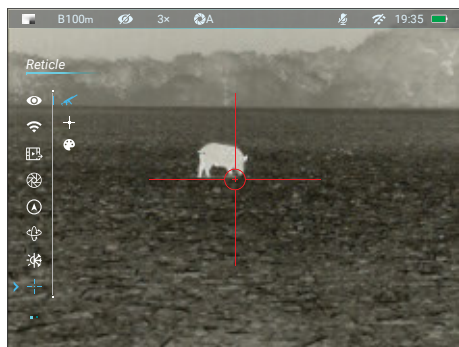
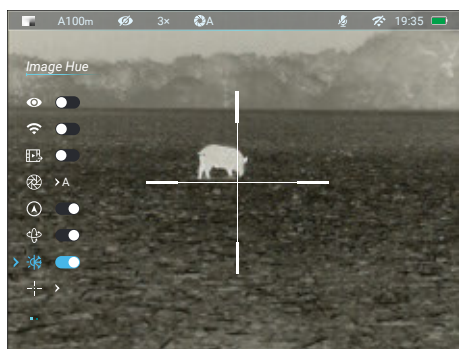

Set the zeroing profile, & reticle type or color

1. Long press the **Menu**  **Button** to enter the main menu.
2. Short press the **Up**  or **Down**  **Button** to select the reticle  menu item.
3. Short press the **Menu**  **Button** to enter the reticle submenu.



RETICLE MENU > ZEROING PROFILE





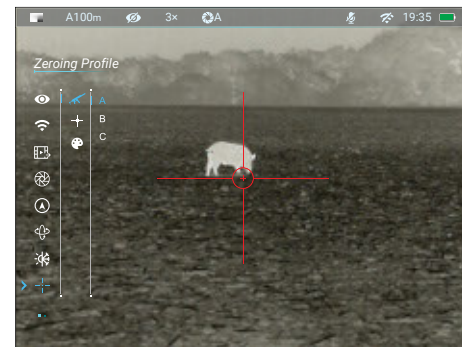

Set the zeroing profile

1. In the reticle submenu, short press the **Up**  or **Down**  **Button** to select the zeroing profile  menu item.
2. Short press the **Menu**  **Button** to enter the submenu.
3. Short press the **Up**  or **Down**  **Button** to move through zeroing profile options: A, B, and C. The selected zeroing profile, A, B, or C, appears in the status bar.
4. Long press the **Menu**  **Button** to confirm the selection and return to the home screen.



RETICLE MENU > RETICLE TYPE

Set the reticle type

1. In the reticle submenu, short press the **Up**  or **Down**  **Button** to select the reticle type  menu item.
2. Short press the **Menu**  **Button** to enter the submenu.
3. Short press the **Up**  or **Down**  **Button** to move through the seven reticle types (see Reticle Types below). The reticle changes as the cursor moves through the options. A custom reticle is also available in the InfiRay Outdoor App.
4. Long press the **Menu**  **Button** to confirm the selection and return to the home screen.

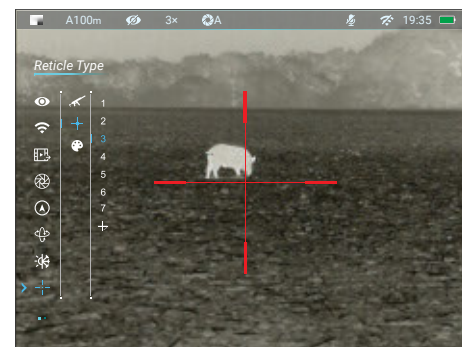



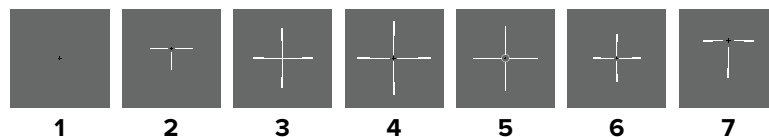



Reticle Types



RETICLE MENU > RETICLE COLOR

Set the reticle color

1. In the reticle submenu, short press the **Up**  or **Down**  **Button** to select the reticle color  menu item.
2. Short press the **Menu**  **Button** to enter the submenu.
3. Short press the **Up**  or **Down**  **Button** to move through reticle color options: black, white, red, or green. The reticle color changes as the cursor moves through the options.
4. Long press the **Menu**  **Button** to confirm the selection and return to the home screen.

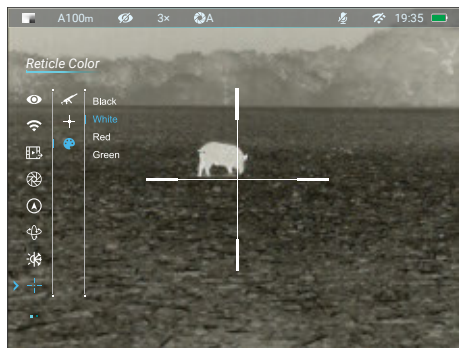





Zeroing

Select or customize zero distance

In the zeroing menu, you can select a preset zero distance, customize a preset zero distance, and adjust the reticle position for the selected zero distance. The RICO V2 supports custom zero distances of 1 to 999 yards or 1 to 999 meters.





NOTE: Before selecting or customizing a zero distance, you must select a zeroing profile, A, B, or C. Each zero profile has three zero distances. See **Reticle Menu > Zeroing Profile** on the previous page.

1. Long press the **Menu**  **Button** to enter the main menu.
2. Short press the **Up**  or **Down**  **Button** to select the zeroing  menu item.
3. Short press the **Menu**  **Button** to enter the zeroing submenu. Three zero distances are shown in the submenu.



ZEROING MENU > ZERO DISTANCE SUBMENU 100m

Select, or customize, a preset zero distance

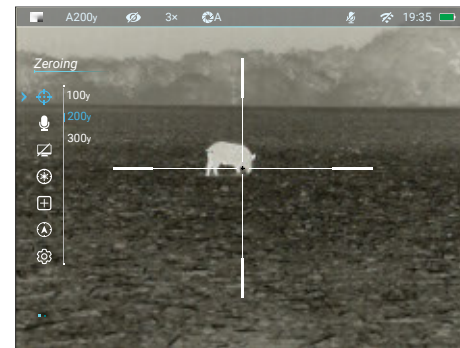

1. In the zero distance submenu, short press the **Up**  or **Down**  **Button** to select a zero distance.
2. Short press the **Menu**  **Button** to enter the submenu for the selected zero distance.
3. In the submenu for the selected zero distance, you may:
 - a. Enter the reticle zeroing interface  to adjust the X/Y position of the reticle at the selected zero distance. See **Reticle Zeroing** below.
 - b. Customize the selected preset zero distance. See **Zeroing Menu > Customize Zero Distance** on page 35.



ZEROING MENU > ZERO DISTANCE SUBMENU > RETICLE ZEROING



Adjust the reticle position of the selected zero distance

In the reticle zeroing interface, the X/Y position of the reticle may be adjusted to match the point of impact.

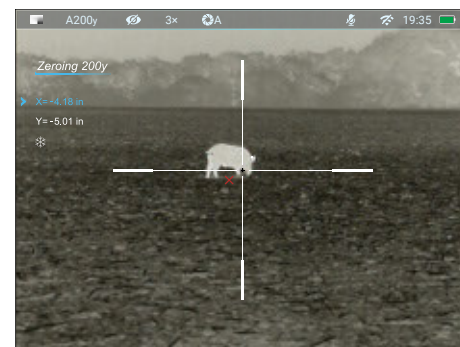
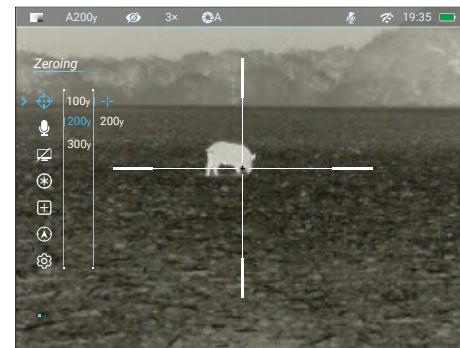
1. In the submenu for the selected zero distance, the reticle zeroing  menu item is selected by default. Short press the **Menu**  **Button** to select and enter the reticle zeroing interface.
2. The reticle zeroing interface has the following features:
 - 1 **X:** Horizontal point of impact change (in cm or inches).
 - 2 **Y:** Vertical point of impact change (in cm or inches).





- 3 Freeze Icon:** Appears when the image is frozen.
- 4 Reticle:** Shows the new reticle position.
- 5 White Dot:** Indicates the center of the original reticle position.





3. Center the reticle on the aiming point and long press the **Zoom**  and **Photo**  **Buttons** at the same time to freeze the image. The image freeze  icon will appear below the X/Y coordinates.





4. Select the axis (X or Y) along which to move the reticle:

- a. Short press the **Up**  or **Down**  **Button** to move between X and Y. The cursor position is indicated by a blue arrow and blue font. X is selected by default.
- b. Short press the **Menu**  **Button** to select X or Y. The selected axis will flash continuously. When deselected, the axis will stop flashing.

5. Adjust the X/Y position of the reticle until the reticle matches the point of impact.









- a. X (horizontal) is the windage and Y (vertical) is the elevation.
- b. Upon moving the reticle, a white dot appears onscreen, representing the original position of the reticle.
- c. Use the **Up**  **Button** to move in the positive direction: X= Right and Y= Up.
- d. Use the **Down**  **Button** to move in the negative direction: X= Left and Y= Down.
- e. Short press the **Up**  or **Down**  **Button** to move the reticle in the corresponding direction by 1 pixel; long press to move 10 pixels.
- f. When adjusting your zero at a distance of 50 yards, a short press will change the impact point by 0.27", and a long press moves 2.71" as shown in the X and Y coordinate displays. At 100 yards that same short press moves 0.54" and a long press moves 5.42". At 200 yards a short press moves 1.08" and a long press moves 10.84".
- g. Changing your zero distance will change the distance of your X/Y adjustments automatically. If your selected zero distance has a correction of 1.63" at 100 yards, it will automatically change to 3.25" if you change the zero distance to 200 yards.

- 6. Short press the **Menu**  **Button** to save the position for the selected axis and deselect it. The axis will stop flashing.
- 7. Repeat 4–6 above to adjust the reticle position along the second axis if needed.
- 8. Long press the **Menu**  **Button** to save the reticle position for both axes and return to the home screen.
- 9. Take a confirmation shot—the point of impact should now match the point of aim. If not, adjust the X/Y position of the reticle again.

ZEROING MENU > ZERO DISTANCE SUBMENU > CUSTOMIZE ZERO DISTANCE

Customize a preset zero distance





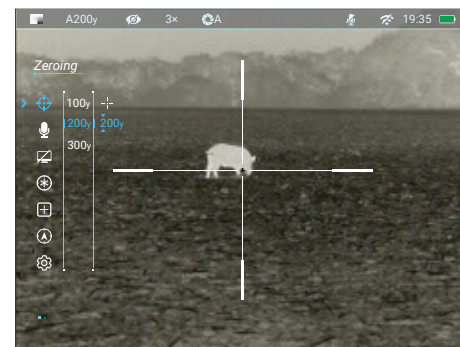



The RICO V2 supports custom zero distances of 1 to 999 yards or 1 to 999 meters.

- 1. In the submenu for the selected zero distance, short press the **Up**  or **Down**  **Button** to select the zero distance customization  menu item (the selected zero distance, for example "109y", will appear instead of "000m").
- 2. Short press the **Menu**  **Button** to customize the selected preset zero distance. A blue arrow will appear above and below the selected digit to mark the cursor location. The far-left digit is selected by default.
- 3. Short press the **Up**  or **Down**  **Button** to increase or decrease the value of the selected digit from 0–9.
- 4. Short press the **Menu**  **Button** to switch between the three digits. The two blue arrows move to indicate the selected digit.
- 5. Long press the **Menu**  **Button** to save the custom zero distance and return to the zero distance submenu.
- 6. The new zero distance appears in the status bar.



Microphone

Turn the microphone on / off



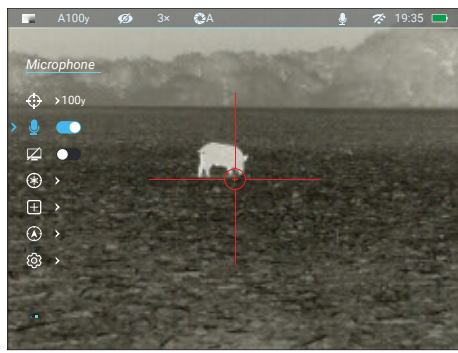



1. Long press the **Menu**  **Button** to enter the main menu.
2. Short press the **Up**  or **Down**  **Button** to select the microphone  menu item.
3. Short press the **Menu**  **Button** to toggle the microphone on / off. The microphone status, on  or off , appears in the status bar.
4. Long press the **Menu**  **Button** to return to the home screen.



Standby

Turn on automatic standby mode

To conserve battery, the RICO V2 may be set to automatically enter standby mode.

1. Long press the **Menu**  **Button** to enter the main menu.
2. Short press the **Up**  or **Down**  **Button** to select the standby  menu item.
3. Short press the **Menu**  **Button** to toggle auto standby on / off. When turned on, the RICO V2 will automatically enter standby mode after 3 seconds of inactivity.
4. Long press the **Menu**  **Button** to confirm the selection and return to the home screen.

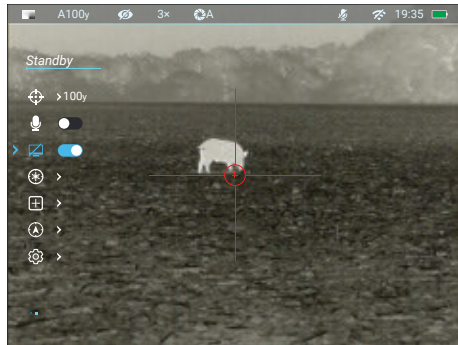

NOTES:

- The motion sensor must be turned on for the auto standby function to work. See **Main Menu > Motion Sensor** on page 29.
- When auto standby mode is turned on:
 - The RICO V2 will enter standby automatically when it is tilted up or down at an angle of more than 70° or left or right at an angle of more than 30°.
 - The RICO V2 will not enter standby mode while it is in a level firing position.

- Short press the **Power**  **Button** to exit auto standby mode and return to the home screen.
- When auto standby is turned off, the rifle scope will operate until the batteries run out.









Laser Calibration

The laser calibration function of the RICO V2 requires an ILR-1000 Laser Rangefinder Module (optional/not included). Please consult the documentation included with your ILR-1000 for more information on its operation.

Pixel Defect Correction

Correct defective pixels



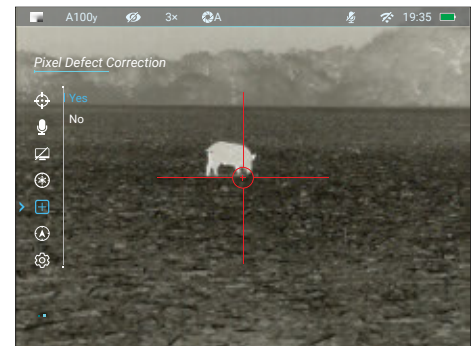
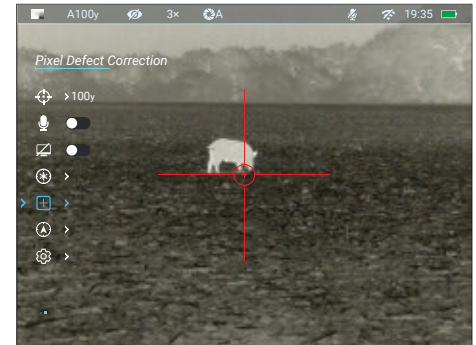

Defective pixels are pixels that do not change correctly compared to the other image pixels—they are either brighter or darker than surrounding pixels. The RICO V2 has a tool that automatically corrects defective pixels on the sensor using its internal software.

1. Long press the **Menu**  **Button** to enter the main menu.
2. Short press the **Up**  or **Down**  **Button** to select the pixel defect correction  menu item.
3. Short press the **Menu**  **Button** to enter the submenu.
4. Two options, Yes and No, appear; Yes will automatically correct any defective pixels on the sensor and No will cancel the operation. Yes is selected by default.
5. Short press the **Menu**  **Button** to select **Yes** to confirm the defective pixel correction. The screen will display “Correcting” while the correction is in progress and will display “Correction successful” when complete; **OR**
6. Short press the **Up**  or **Down**  **Button** to select **No** and short press the **Menu**  **Button** to confirm cancellation of the pixel correction and return to the submenu.



Compass Calibration



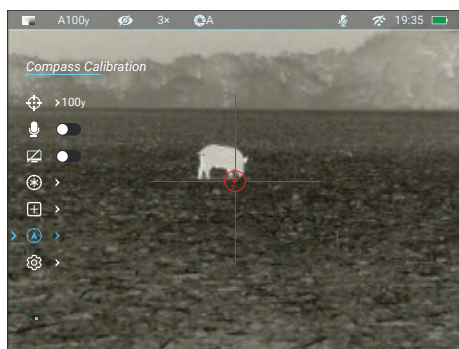

Calibrate the digital compass

1. Long press the **Menu ** Button to enter the main menu.
2. Short press the **Up ** or **Down ** Button to select the compass calibration  menu item.
3. Short press the **Menu ** Button to begin compass calibration. A triaxial coordinate prompt will appear on the screen.
4. Follow the prompt to rotate the RICO V2 at least 360 degrees along each axis, X, Y, and Z. Rotations must be completed within the 30-second calibration time.
5. After 30 seconds, the calibration is finished and the RICO V2 will automatically return to the home screen.



Settings





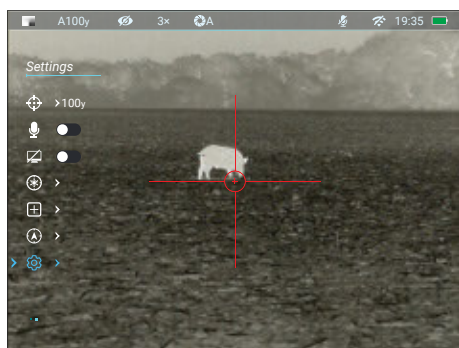



Adjust the general settings

1. Long press the **Menu ** Button to enter the main menu.
2. Short press the **Up ** or **Down ** Button to select the settings  menu item.
3. Short press the **Menu ** Button to enter the settings submenu.



SETTINGS MENU > DATE





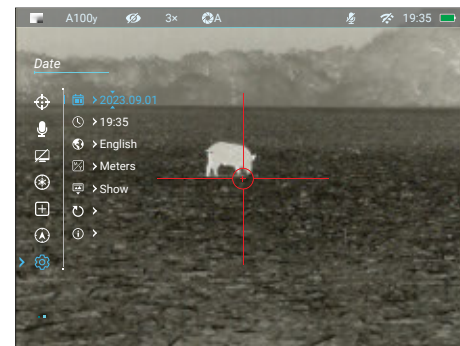



Set the date

1. In the settings submenu, short press the **Up ** or **Down ** Button to select the date  menu item.
2. Short press the **Menu ** Button to edit the date. A blue arrow will appear above and below the year digit. The date is displayed in YYYY.MM.DD format.
3. Short press the **Up ** or **Down ** Button to select the correct value for each digit (year, month, and day).
4. Short press the **Menu ** Button to switch between digits. The two arrows move to indicate the selected digit.
5. Long press the **Menu ** Button to save the date and return to the home screen.



SETTINGS MENU > TIME





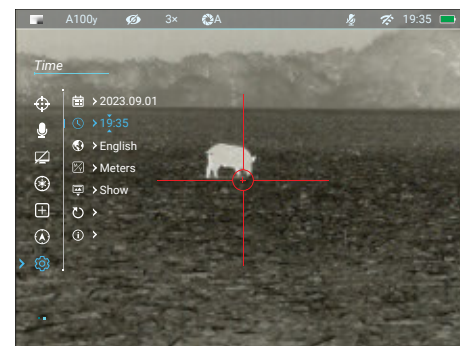

Set the time

1. In the settings submenu, short press the **Up ** or **Down ** Button to select the time  menu item.
2. Short press the **Menu ** Button to edit the time. A blue arrow will appear above and below the hour digit. The time is displayed in HH.MM, in 24-hour format.
3. Short press the **Up ** or **Down ** Button to select the correct value for each digit (hour and minute).
4. Short press the **Menu ** Button to switch between digits. The two arrows move to indicate the selected digit.
5. Long press the **Menu ** Button to save the time and return to the home screen.
6. The time appears in the status bar.



SETTINGS MENU > LANGUAGES





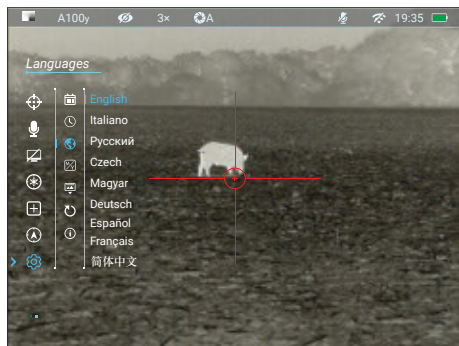

Select the languages

1. In the settings submenu, short press the **Up**  or **Down**  **Button** to select the language  menu item.
2. Short press the **Menu**  **Button** to enter the submenu.
3. Short press the **Up**  or **Down**  **Button** to move through the language options. English is selected by default.
4. Long press the **Menu**  **Button** to confirm the selection and return to the home screen.



SETTINGS MENU > UNIT

Set the units of measurement

1. In the settings submenu, short press the **Up**  or **Down**  **Button** to select the unit  menu item.
2. Short press the **Menu**  **Button** to enter the submenu.
3. Short press the **Up**  or **Down**  **Button** to move through unit options, meters and yards. The selected units, m (meters) or y (yards), will display, along with the selected zero profile and distance, in the status bar.
4. Long press the **Menu**  **Button** to confirm the selection and return to the home screen.

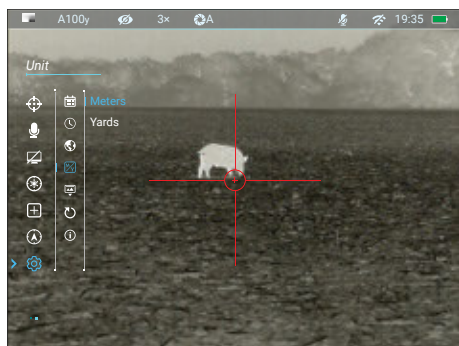







SETTINGS MENU > STATUS BAR

Turn status bar auto-hiding on / off

This function enables all interface information, aside from the reticle, to be automatically hidden for unobstructed image view.

When auto-hide is turned on, after 8 seconds of inactivity the status bar, digital compass, and all interface icons will be automatically hidden. Shortcut buttons and the menu are disabled until the entire interface is again displayed. Press any button to show all interface information again.



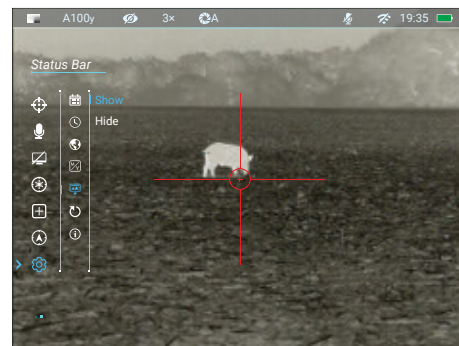

NOTE: When auto-hide is on, the main menu, when open, will hide after 15 seconds of inactivity and the rest of the RICO V2 interface will hide after an additional 8 seconds.

1. In the settings submenu, short press the **Up**  or **Down**  **Button** to select the status bar  menu item.
2. Short press the **Menu**  **Button** to enter the submenu.
3. Short press the **Up**  or **Down**  **Button** to move through options, show and hide. Hide will turn on the auto-hide function and show will turn it off.
4. Long press the **Menu**  **Button** to confirm the selection and return to the home screen.



SETTINGS MENU > FACTORY RESET

Restore factory default settings

1. In the settings submenu, short press the **Up**  or **Down**  **Button** to select the factory reset  menu item.
2. Short press the **Menu**  **Button** to enter the factory reset submenu.
3. Two options, Yes and No, appear; Yes will restore factory settings and No will cancel the operation. Yes is selected by default.

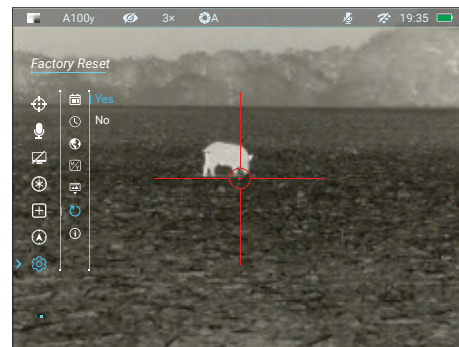

4. Short press the **Menu** **[M]** **Button** to select **Yes** to confirm the factory reset. Factory settings will be restored and the RICO V2 will reboot automatically; **OR**
5. Short press the **Up** **[Q]** or **Down** **[E]** **Button** to select **No** and short press the **Menu** **[M]** **Button** to confirm cancellation of the factory reset and return to the submenu.

NOTES:

- There is a pause of about 10 seconds before the factory restart begins. Do not press any buttons during this time.
- A factory reset cannot be undone.
- The settings listed below will be reset to the factory defaults:
 - Color Palette: White Hot
 - Zeroing Profile: A
 - Display Brightness: 3
 - Reticle Type: 1
 - Image Sharpness: 5
 - Reticle Color: Black
 - Image Brightness: 5
 - Microphone: Off
 - Image Contrast: 5
 - Standby: Off
 - Magnification: 3×
 - Language: English
 - Ultra-Clear mode: Off
 - Unit: Meters
 - Wi-Fi: Off
 - Status Bar: Hide
 - Video Output: Off
 - Wi-Fi Password: 12345678
 - Calibration: Automatic
 - Wi-Fi SSID: RH50V2_YYYYY_YYYYYYYY
 - Digital Compass: Off
 - Motion Sensor: Off

SETTINGS MENU > INFO ⓘ

Show device information

1. In the settings submenu, short press the **Up** **[Q]** or **Down** **[E]** **Button** to select the info ⓘ menu item.
2. Short press the **Menu** **[M]** **Button** to enter the info submenu.
3. The info submenu will display the following information about the RICO V2: the model number, the GUI, SYS, boot, and FPGA versions, and the PN and SN numbers.
4. Long press the **Menu** **[M]** **Button** to save and return to the home screen.



25. WARRANTY

At iRayUSA we're first and foremost hunters and users of our products and we understand that failure isn't an option. We also understand that having to wait extended periods for repair isn't something that a customer should have to put up with when something does go wrong. During your published warranty period, iRayUSA will repair or replace, at its discretion, any optic that becomes defective during normal use. Additionally, if we cannot fix your optic in less than one week, we will offer to replace it with a replacement product in like or better condition. If you would rather wait for your specific optic to be repaired, we can handle that too.

We know you've never seen this from a thermal manufacturer, and neither have we, and that's why we started iRayUSA.

Our warranty follows the product and is not tied to the original owner. The warranty period is tied to the date of sale to the dealer. This warranty only covers normal use and does not cover cosmetic damage, normal wear, intentional damage, theft, loss, any act of God, or a condition caused by use other than intended. Any product that is modified, opened, or tampered with will void any warranty coverage. Any serial number damage or alteration on the product will be considered a modification. Be sure to register your RICO V2 rifle scope at irayusa.com/register.

To return a product for repair:

1. Go to irayusa.com/warranty and click the **Request an RMA button** to request an RMA number. Returns will not be accepted without an RMA.
2. The customer is responsible for shipping the product to iRayUSA, per the instructions included in the RMA. iRayUSA will return the product at no cost.

WARRANTY NOTES:

- The one-week timeline starts from the time of receipt of the product at iRayUSA.
- iRayUSA is not liable for any damages or loss incurred when shipping to iRayUSA.
- This warranty gives you specific legal rights, and you may also have other rights which vary from state to state.

Please give us a call at **800-769-7125**, visit irayusa.com/warranty, or email info@irayusa.com with any questions.

26. BASIC MAINTENANCE

Always replace the objective lens cap (1) after use to avoid damaging or scratching the lens. Never touch the lens directly; oil from your skin can damage the lens coating and surface.

Basic maintenance should be carried out at least twice a year and includes the following steps:

- Wipe the surface of the external metal and plastic components with a clean, dry cotton cloth. Do not use chemical, corrosive, or abrasive cleaners. Canned air may also be used to clean the external components.
- Clean the electric contacts and battery slots on the rifle scope using a non-greasy organic solvent.
- Check the lens and eyepiece. If necessary, remove any dirt or sand from the optics; a non-contact cleaning method is preferred.
- Cleaning the exterior of the lens should only be done with the included microfiber lens cloth or a similar product. Only clean the lens when it is visibly soiled. Frequent wiping or cleaning can degrade the anti-reflective lens coating.

27. BASIC INSPECTION

It is recommended to carry out a technical inspection before each use. Please check the following:

- The rifle scope appearance: there should be no cracks in the body or visible damage.
- The condition of the objective lens and eyepiece: there should be no cracks, greasy spots, dirt, or other deposits on the lens.
- The internal rechargeable battery pack should be fully charged.
- The control buttons should be in working order.

28. GENERAL TROUBLESHOOTING

The troubleshooting table below lists issues that may occur when operating the RICO V2. Carry out the recommended troubleshooting steps in the order shown in the table. Please contact iRayUSA at 800-769-7125 or irayusa.com/support or an authorized vendor for assistance before attempting to perform any modifications or repairs beyond the scope of the troubleshooting procedures in this manual. Unauthorized repairs or modifications will void your warranty.

| ISSUE | POSSIBLE CAUSES |
|--|--|
| The RICO V2 will not turn on. | The built-in battery pack is very low or has completely discharged. |
| The RICO V2 can not connect to a computer or external power supply. | External power supply has completely discharged. |
| | Computer is turned off. |
| | Data cable is damaged. |
| Video output is not working. | Video output is not turned on |
| The RICO V2 can not connect to the mobile device (smartphone or tablet). | Wi-Fi is not turned on. |
| | Wrong Wi-Fi password entered. |
| | Too many Wi-Fi signals near the RICO V2. |
| Wi-Fi signal is lost or interrupted. | Smartphone or tablet is out of range of a strong Wi-Fi signal, or there are obstacles between the RICO V2 and the mobile device. |

| TROUBLESHOOTING STEPS |
|--|
| Charge the built-in battery pack. |
| Check the external power supply and charge it if necessary. |
| Power on the computer. |
| Replace the data cable. |
| Turn on video output in the main menu. See Main Menu > Video Output on page 28. |
| Turn on the Wi-Fi in the main menu. See Main Menu > Wi-Fi on page 27. |
| On the mobile device, go to Settings > Wi-Fi and enter the correct password. The default password is 12345678. See Main Menu > Wi-Fi on page 27. |
| Move the RICO V2 and mobile device to an area with no or fewer Wi-Fi signals. |
| <ul style="list-style-type: none"> • Try again when Wi-Fi signal is stable. • Relocate the RICO V2 closer to the Wi-Fi signal. |

| ISSUE | POSSIBLE CAUSES |
|---|---|
| The image is fuzzy, not clear, unbalanced, or it has artifacts. | Non-uniformity correction is required. |
| The image is too dark. | Display brightness level is too low. |
| The GUI is clear, but the image is fuzzy. | The lens is not focused. |
| | There is dust on the external optical surface of the lens. |
| | There is condensation on the internal or external optical surface of the lens. |
| The aiming reticle shifts after firing rounds. | The RICO V2 is not mounted securely or the mount is not secured on the RICO V2. |
| The image of the object being observed is missing. | Looking through glass. |
| The RICO V2 will not focus. | Image settings are not optimal for the current environmental conditions or the object being observed. |
| Image quality is too low or the detection range is reduced. | These issues may occur due to the weather conditions, such as snow, rain, humidity, and fog. |
| When the RICO V2 is used in low-temperature conditions, the image quality of the surroundings is worse than in warm-temperature conditions. | Environmental conditions. |

| TROUBLESHOOTING STEPS |
|--|
| Perform a non-uniformity correction. See Non-uniformity Correction on page 21. |
| Adjust the display brightness in the quick menu. See Using the Quick Menu on page 18. |
| <ul style="list-style-type: none"> Adjust the focus on the target by rotating the Objective Focus Knob (2). Adjust the image sharpness in the quick menu. See Using the Quick Menu on page 18. |
| <ul style="list-style-type: none"> Wipe the external optical surface with the included microfiber lens cloth. |
| <ul style="list-style-type: none"> Wipe the external optical surface with the included microfiber lens cloth. Allow the RICO V2 to dry by leaving it in a warm, dry environment for at least 4 hours. |
| <ul style="list-style-type: none"> Check that the RICO V2 has been securely mounted. Make sure you are using the same brand, type, and weight of the bullets as when the RICO V2 and weapon were initially zeroed. If the RICO V2 was zeroed in different environmental conditions, a slight shift of the zero is possible. |
| Remove any glass windows from the field of view. |
| <ul style="list-style-type: none"> Check the external surface of the objective lens and eyepiece and wipe away any dust, condensation, frost, etc. In cold weather, you can use special anti-fogging coatings, such as those made for corrective glasses. Adjust the focus on the target by rotating the Objective Focus Knob (2). Adjust the image sharpness in the quick menu. See Using the Quick Menu on page 18. Adjust the image and device settings. See Quick Start Guide on page 8. Turn on Ultra-Clear mode. See Main Menu > Ultra-Clear on page 27. |
| Turn on Ultra-Clear mode. See Main Menu > Ultra-Clear on page 27. |
| In warm-temperature conditions, objects being observed (surroundings and background) heat up differently because of thermal conductivity, thereby generating a high-temperature contrast. Accordingly, the image quality produced by the rifle scope will be higher. In low-temperature conditions, the background will cool down to roughly the same temperature, and thus the temperature contrast is substantially reduced and image detail can go down as there is less contrast in the scene. This is a normal function of a thermal imager and is no indicator of actual detector performance. |



**2601 State Hwy 121,
Building 3, Suite 306
Lewisville, TX 75056
800-769-7125
682-499-0047
info@irayusa.com
PN: IRAY-PR182**