

User's Manual

INFIRAY OUTDOOR
BOLT-C SERIES

Bolt Action Optimized Thermal Rifle Scope



WARNING! ITAR REQUIREMENTS

These products may be subject to export and foreign trade control laws of the United States and may not be exported without prior approval of the U.S. Department of State. Learn more at irayusa.com/ITAR.

FCC ID 2AYGT-2D00

This device complies with part 15 of the FCC Rules. Operation is subject to the following two conditions: (1) This device may not cause harmful interference, and (2) this device must accept any interference received, including interference that may cause undesired operation.

CAUTION: Changes or modifications not expressly approved by IRayUSA could void the user's authority to operate the equipment.

NOTE: This equipment has been tested and found to comply with the limits for a Class B digital device, pursuant to part 15 of the FCC Rules. These limits are designed to provide reasonable protection against harmful interference in a residential installation. This equipment generates, uses and can radiate radio frequency energy and, if not installed and used in accordance with the instructions, may cause harmful interference to radio communications. However, there is no guarantee that interference will not occur in a particular installation. If this equipment does cause harmful interference to radio or television reception, which can be determined by turning the equipment off and on, the user is encouraged to try to correct the interference by one or more of the following measures:

- Reorient or relocate the receiving antenna.
- Increase the separation between the equipment and receiver.
- Connect the equipment into an outlet on a circuit different from that to which the receiver is connected.
- Consult the dealer or an experienced radio/TV technician for help.

This device was tested for typical body-supported operations and use. To comply with RF exposure requirements, a minimum separation distance of 0.5cm must be maintained between the user's body and the handset, including the antenna. Third-party belt-clips, holsters, and similar accessories used by this device should not contain any metallic components. Body accessories that do not meet these requirements may not comply with RF exposure requirements and should be avoided. Use only the supplied or an approved antenna.

TABLE OF CONTENTS

1. Overview	2
2. Features	2
3. Tech Specs	3
4. Accessories	4
5. Components and Controls	5
6. Product Dimensions	5
7. Description of Control Buttons and Shortcuts	6
8. Quick Start Guide	8
9. Charging the Built-in Battery Pack	10
10. Installing an Auxiliary Battery	11
11. Battery Status Indicators	12
12. Switching the Battery Power Supply.....	13
13. Battery Safety Precautions	13
14. External Power Supply	14
15. Mounting the BOLT-C	15
16. Operating Instructions	16
17. Zeroing the BOLT-C	23
18. Non-Uniformity Correction	24
19. Photography and Video Recording	24
20. Accessing the Internal Memory	26
21. Video Output.....	27
22. Connecting to Wi-Fi	27
23. Using the InfiRay Outdoor App	30
24. Digital Zoom.....	31
25. Picture in Picture (PIP).....	31
26. Stadiametric Rangefinder	32
27. Ultra-clear Mode	33
28. Main Menu Options and Descriptions.....	33
29. Basic Inspection	49
30. Basic Maintenance	49
31. Warranty.....	50
32. General Troubleshooting	51

1. OVERVIEW

The BOLT-C Series expands on the success of the BOLT with the addition of our industry-leading 12 μ m 640 \times 512 Micro II sensor, a 2560 \times 2560 Micro-OLED HD display, and a Shutterless Calibration feature. The BOLT-C Series maintains the traditional look and flexibility of a 30mm ring-mounted interface, while its proven combination of a manual-focus lens, dual-battery design, and tactile control turret work in tandem with its pixel-dense display to provide an improved viewing experience and an unmatched level of precision for your next hunt.

2. FEATURES

- 12 μ m iRay Micro II thermal sensor
- High-resolution display
- Variable digital zoom magnification
- Dual-power supply solution for extended operation
- Traditional 30mm diameter housing design
- Stadiametric rangefinder
- 1750–2400 yard detection range
- 50Hz image refresh rate
- 32 GB internal storage
- Wi-Fi module for external connectivity to App
- Digital compass and gravity sensor
- Picture in Picture (PIP)
- Defective pixel correction
- Extended eye relief
- Cold and warm image temperature options
- User-friendly interface

3. TECH SPECS

BOLT-C SERIES	TH50C	TH35C
SENSOR		
Resolution	640 \times 512	
Pixel Size	12 μ m	
Frame Rate	50 Hz	
Image Processing	MATRIX III	
Core	iRay MICRO II 640	
OPTICS		
Objective Lens	50 mm /f1.1	35 mm /f1.1
Magnification	3.5 \times	2.5 \times
Digital Zoom	4 \times	
Field of View	8.8 $^{\circ}$ \times 7.0 $^{\circ}$	12.5 $^{\circ}$ \times 10.0 $^{\circ}$
Detection Range	2400 Yards	1750 Yards
Display Type	Micro OLED	
Display Resolution	2560 \times 2560	
Imaging Modes	White Hot, Black Hot, Red Hot, Color, Highlight	
Reticle Types	7 (2 Dynamic, 5 Static)	
Reticle Colors	Black, White, Red, Green	
Mounting System	30mm Rings (included)	
P.I.P	Yes	
Rangefinder	Stadiametric	
Eye Relief	50mm	
Diopter Range	-5 to +5	
ELECTRONICS		
Onboard Recording	Video and Image	
Onboard Storage	32 GB	
Wireless Connectivity	Video and Image via App	
Data/Power Connector	USB-C	
Power Supply	Built-in Battery Pack (8 Hours), 18500 Battery (+2 Hours), 18650 Battery (+3.5 Hours)	
Start Up Time	< 10 Seconds, Instant from Standby	
PHYSICAL		
Size	14.56" \times 3.34" \times 2.95"	
Weight	33.15 oz	32.09 oz
ENVIRONMENTAL/WARRANTY		
Warranty	5 Years	
Housing Material	T-6061 Aluminum	
Ingress Protection	IP67	
Operation Temperature	-4 $^{\circ}$ F \sim 122 $^{\circ}$ F	
Max. Recoil	1000 g/s ² (300 Win./7mm Mag)	

4. ACCESSORIES

The BOLT-C Series ships with everything you need to get out and hunt. The included items are as follows:

- BOLT-C Series Thermal Imaging Rifle Scope
- Objective lens cap
- Eyeshade
- 30mm ring mounts for picatinny rail
- Soft case
- USB-C cable for data/video
- Wall adapter
- Lens cloth
- User manual



Optional and replacement accessories for the BOLT-C Series are available to customize your experience and those include:

PART NO.	DESCRIPTION
IRAY-AC08	USB-C to Analog RCA/USB Cable 36"
IRAY-AC12 / 57	Objective Lens Cap for 35mm/50mm Mk1/BOLT
IRAY-AC15	Standard Rubber Eyeguard for Mk1/BOLT
IRAY-AC18	BOLT Standard Scope Mount Rings
IRAY-AC37	BOLT-C 18650 Battery Extender*
IRAY-AC62 / 67	BOLT 35mm/50mm Objective Focus Cat Tail

*For use with 18650 auxiliary battery (optional/not included)

5. COMPONENTS AND CONTROLS

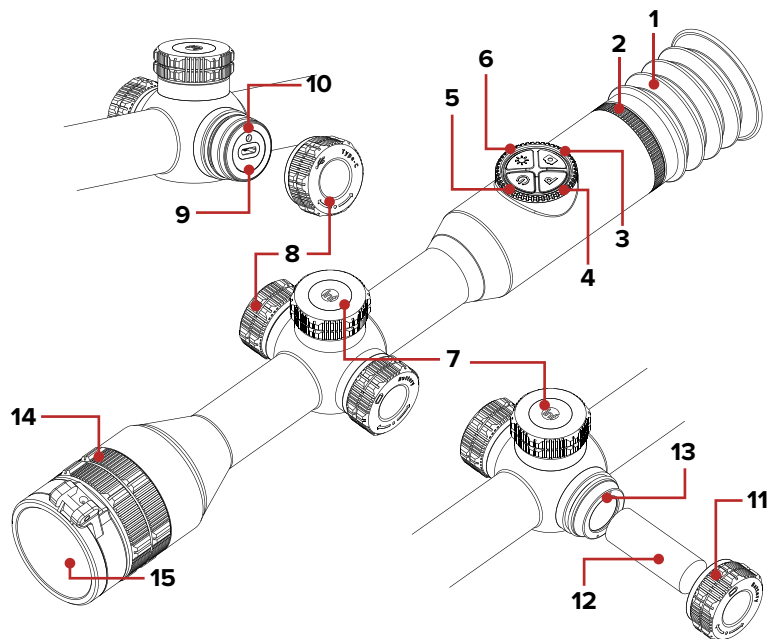

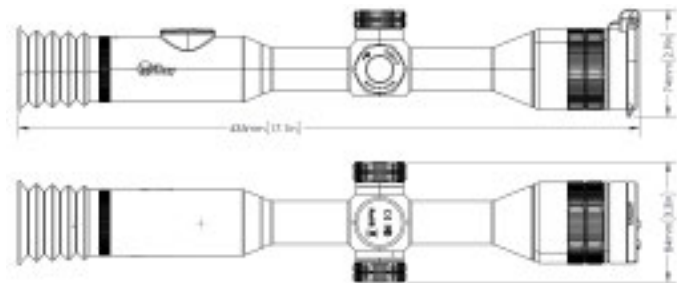

- 1 Eyeguard
- 2 Eyepiece Diopter Adjustment Ring
- 3 Photo Button
- 4 Palette Button
- 5 Power Button
- 6 Brightness Button
- 7 Tactile Control Turret
- 8 USB-C Port Cover
- 9 USB-C Port
- 10 LED Status Indicator
- 11 Auxiliary Battery Cover
- 12 18500/18650 Auxiliary Battery (optional/not included)
- 13 Auxiliary Battery Compartment
- 14 Objective Lens Focus Ring
- 15 Objective Lens Cap

6. PRODUCT DIMENSIONS



7. DESCRIPTION OF CONTROL BUTTONS AND SHORTCUTS

Power Button 		
Current Screen / Menu or Device Status	Short Press	Long Press
Device off	---	Power on the device
Home screen	Perform a manual non-uniformity correction	Power off the device; enter standby mode
Standby mode	Exit standby mode	---
Main menu	Return to previous without saving changes	---
Defective pixel correction interface	Add or remove defective pixel from the "to be corrected list"	---
Reticle zeroing interface	Exit interface and return the reticle to the last saved zero position	---

Palette Button 		
Current Screen / Menu	Short Press	Long Press
Home screen	Switch the imaging mode	Turn PIP window on / off

Palette + Brightness Button  + 		
Current Screen / Menu	Short Press	Long Press
Home screen	---	Activate / deactivate the reticle

Brightness Button 		
Current Screen / Menu	Short Press	Long Press
Home screen	Adjust the screen brightness	Enter / exit the stadiametric rangefinder

Photo Button 		
Current Screen / Menu	Short Press	Long Press
Home screen	Take a photo	Start / stop recording video



Photo + Palette Button  + 		
Current Screen / Menu	Short Press	Long Press
Reticle zero interface	---	Freeze image to keep reticle centered on aiming point; press again to clear frozen image

Photo + Brightness Button  + 		
Current Screen / Menu	Short Press	Long Press
Reticle zero interface	---	Return reticle to the center

Control Turret			
Current Screen / Menu	Short Press	Long Press	Rotate
Home screen	Enter quick menu	Enter main menu	Adjust digital zoom level
Quick menu	Adjust parameters for a menu item	Return to home screen	Switch menu options; move menu cursor; move reticle position
Main menu	Confirm changes; open the submenu	Return to home screen	
Reticle zero interface	Switch between X and Y	Save changes and exit to home screen	Clockwise: Move left / down
Defective pixel correction interface	Switch between X and Y	Save changes and exit to home screen	Counterclockwise: Move right / up

8. QUICK START GUIDE

Step 1: Preparing to Use the BOLT-C Series

1. Compare the box contents to the accessories list and examine each for any shipping damage. See **Accessories** on page 4.
2. Check the lens to ensure there are no smudges or dirt present. Clean with the included lens cloth, if necessary.
3. Install the eyeguard (1).
4. Charge the built-in battery pack before using the BOLT-C for the first time. See **Charging the Built-in Battery Pack** on page 10.
5. Mount the BOLT-C to the weapon using the included 30mm rings. See **Mounting the BOLT-C** on page 15.



Step 2: Turn On the BOLT-C and Adjust the Focus

1. Open the objective lens cap (15).
2. Long press the **Power**  **Button** for 2 seconds to power on the BOLT-C. The InfiRay logo will appear.
3. Rotate the diopter adjustment ring (2) of the eyepiece until the interface icons are clearly visible.
4. Rotate the objective lens focus ring (14) to focus on the object being observed.

WARNING: Do not point the objective lens toward intense energy sources, such as the sun. This may render the electronic components inoperative. The warranty does not cover damage caused by improper operation.

Step 3: Activate and Customize the Reticle





From the home screen:

1. Press and hold the **Brightness**  and **Palette**  **Buttons** at the same time for 15 seconds to activate the reticle.
2. Short press the **Control Turret** to enter the quick menu (see **Using the Quick Menu** on page 21):
 - a. Select the reticle type, from 1–6. The default type is 1.
 - b. Select the reticle color, white, black, red, or green. The default is white.

Step 4: Adjust the Image Settings

From the home screen:

1. Short press the **Palette**  **Button** to set the imaging mode, white hot, black hot, red hot, highlight, or color. White hot is the default.

2. Short press the **Brightness**  **Button** to adjust the screen brightness, from level 1–5. The screen brightness  icon and 5 bars appear at the bottom of the screen. The default is 3.
3. Short press the **Control Turret** to enter the quick menu to adjust the image sharpness, from 1–5. The default is 3. See **Using the Quick Menu** on page 21.
4. Short press the **Power**  **Button** to perform a non-uniformity correction, as needed. See **Non-Uniformity Correction (NUC)** on page 24.
5. Rotate the **Control Turret** to zoom in and out on the observed object. See **Digital Zoom** on page 31.
6. Long press the **Palette**  **Button** to turn on the PIP window, if desired. See **Picture in Picture (PIP)** on page 31.
7. Long press the **Control Turret** to enter the main menu to:
 - a. Turn on Ultra-clear mode to enhance the image contrast in inclement weather, if needed. See **Main Menu > Ultra-clear** on page 34.
 - b. Select the image hue, warm or cold. The default is cold. See **Settings Menu > Image Hue** on page 47.

Step 5: Adjust Rifle Scope Settings

1. From the home screen, long press the **Control Turret** to enter the main menu to:
 - a. Turn on the digital compass. See **Main Menu > Compass** on page 35.
 - b. Turn on the gravity sensor. See **Main Menu > Gravity Sensor** on page 36.
 - c. Calibrate the digital compass. See **Main Menu > Compass Calibration** on page 44.
 - d. Set the date and time. See **Settings Menu > Date and Settings Menu > Time** on page 45.
 - e. Set the units of measurement, meters or yards. The default is yards. See **Settings Menu > Units of Measure** on page 46.

Step 6: Zero the BOLT-C

1. From the home screen, long press the **Control Turret** to enter the main menu to:
 - a. Select the zeroing profile, A, B, or C. See **Main Menu > Zeroing Profile** on page 36.
 - b. Select, or customize, a preset zero distance that matches the target distance. See **Zeroing Menu** on page 37.
 - c. Zero the reticle. See **Zeroing Menu > Reticle Zeroing** on page 38.

9. CHARGING THE BUILT-IN BATTERY PACK

The BOLT-C Series has a dual power supply: a built-in rechargeable li-ion battery pack and an optional auxiliary battery (18500 or 18650 with adapter; batteries not included). The dual-battery system supports a run time of 8 hours out of the box and 10+ hours when using an auxiliary battery.

The built-in battery pack is not removable or replaceable. Please ensure the battery pack is fully charged before the first use.

To charge the battery pack:

1. Remove the USB-C port cover (8) by turning it counterclockwise.
2. Plug the smaller USB-C end of the data cable into the USB-C port (9).
3. Plug the larger USB end of the data cable into the USB power adapter, and plug the power adapter into a wall outlet.
4. While charging, the LED status indicator (10) above the USB-C port will turn red. When the indicator LED turns green, the battery is fully charged.

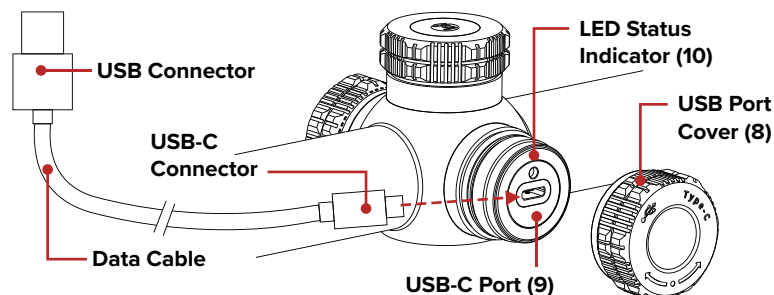

5. On screen, a charging ⚡ icon appears above the built-in battery status indicator in the bottom-right corner.
6. When fully charged, disconnect the data cable from the USB-C port and replace the USB-C port cover (8).
 - a. It takes about 3–5 hours to charge the battery. Do not overcharge.
 - b. See **Battery Status Indicators** on page 12 for additional battery information.

WARNING: Never charge the battery pack with a USB adapter that is greater than 5V–2A.

NOTES:

- You may charge and operate BOLT-C at the same time.
- Only the built-in battery pack will be charged while connected via the USB-C port.

10. INSTALLING AN AUXILIARY BATTERY

The optional auxiliary battery compartment allows the BOLT-C's run-time to be expanded to 10+ hours. 18500, or 18650 with adapter, rechargeable li-ion batteries (optional/not included) are compatible with the BOLT-C.

Ensure the 18500/18650 auxiliary battery is fully charged before using with the BOLT-C for the first time.

To install an auxiliary battery:

1. Remove the auxiliary battery cover (11) by turning it counterclockwise.
2. Insert a 18500 battery (or 18650 plus adapter) (12) into the auxiliary battery compartment (13) following the polarity markings inside the compartment. The positive [+] battery terminal faces in and the negative [-] terminal faces out.
3. Replace the battery cover (11).

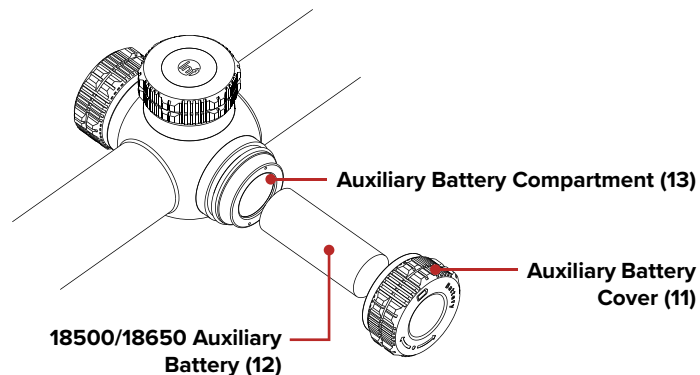

NOTE: If using a 18650 battery, you will need to replace the standard auxiliary battery cover (11) with the IRAY-AC37 BOLT-C 18650 Battery Extender.

11. BATTERY STATUS INDICATORS

The status indicator for the built-in battery pack appears in the bottom-right corner of the screen.

If an optional auxiliary battery is installed in the BOLT-C, a status indicator for the auxiliary battery appears in the bottom-left corner.

The status indicator for the active battery (the battery currently being used to power the BOLT-C) is displayed in color, and the status indicator for the inactive battery is displayed in gray.

Each battery status indicator has 5 bars which indicate the current battery charge level, see the table below. The color of the indicator bars for the active battery also indicate the current charge.

A charging ⚡ icon appears above the battery status indicator when the built-in battery pack is charging.

Charge the built-in battery pack before it reaches <5% (no bars) to avoid over-discharge and potential damage to the battery.

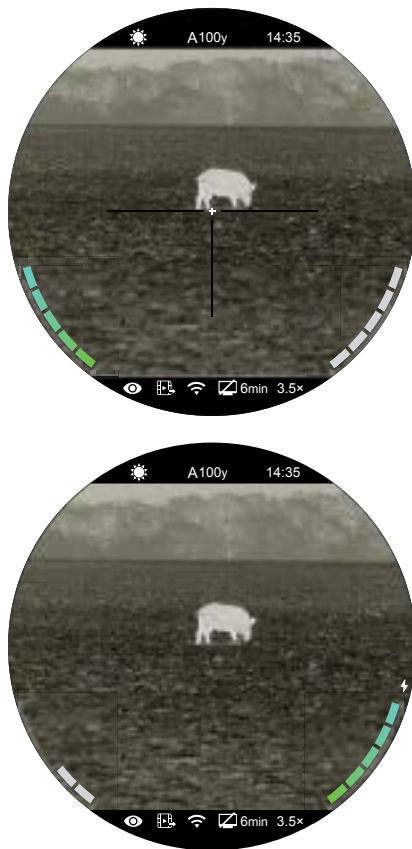

12. SWITCHING THE BATTERY POWER SUPPLY

The BOLT-C Series has a dual power supply system with a built-in li-ion battery pack and an auxiliary battery option. 18500, or 18650 with adapter, rechargeable li-ion batteries (optional/not included) are compatible with the BOLT-C.

Using with the Optional Auxiliary Battery

- When both the built-in battery pack and the auxiliary battery are fully charged, the BOLT-C will select the auxiliary battery as its primary power source.
- If the power of the auxiliary battery is low, or the auxiliary battery is removed, the BOLT-C will automatically switch to the built-in battery pack as its primary power supply. Operation will not be interrupted during this time.
- When the BOLT-C is in use, you may insert (or replace) an auxiliary battery without powering off. Power will automatically switch to the built-in battery during replacement of the auxiliary battery.

Using with an External Power Source

When the data cable is used to connect the BOLT-C, via the USB-C port, to a computer or external power source (such as a standard wall outlet or an external power supply), the rifle scope will switch to the external power source and begin charging the built-in battery pack. See **External Power Supply** on the next page for more information.

A charging ⚡ icon appears above the battery status indicator for the built-in battery pack in the bottom-right corner of the screen, indicating that the battery is charging. See **Battery Status Indicators** on page 12.

NOTE: Only the built-in battery pack will be charged while connected via the USB-C port.

13. BATTERY SAFETY PRECAUTIONS

Only charge the BOLT-C with a standard USB adapter (5V–2A), as included in the BOLT-C kit. Using any other types of adapters may lead to irreversible damage to the battery, adapter, or rifle scope. This damage is not covered under warranty.

If your BOLT-C has been stored for an extended period, it should be charged before initial use.

WARNINGS:

- Avoid storing a fully charged or discharged battery for extended periods.

BARS	COLORS	BATTERY STATUS
5 Bars	Solid Green	81% – 100%
4 Bars	Green to Blue	61% – 80%
3 Bars	Green to Blue	41% – 60%
2 Bars	Yellow to Orange	20% – 40%
1 Bar	Orange to Red	5% – 20%
0 Bars	Dark Gray	<5%; charge the battery right away
Charging Icon ⚡		The built-in battery pack is charging (external power supply or computer is connected via the data cable)

- Do not charge an extremely cold battery without bringing it into a warm environment. Let the battery warm up for 45 minutes before charging.
- Do not use any USB cable or power adapter that has been modified or damaged to charge the BOLT-C.
- Charge the BOLT-C at a temperature range from 30°F to 100°F, otherwise the battery life will be reduced significantly.
- Do not leave the BOLT-C unattended while charging.
- Avoid leaving the BOLT-C connected to the USB power adapter for extended periods after it has been fully charged.
- The BOLT-C has a short-circuit protection system. However, any situation that may cause short-circuiting should be avoided.
- The recommended operation temperature range is -4°F to 122°F. Avoid operating out of this temperature range, otherwise you may experience a shortened battery life.
- Avoid using the battery pack above the maximum or below the minimum recommended temperature listed above as this may decrease the battery pack capacity or service life. This is considered normal operation and should not be considered a defect.
- Keep the battery pack out of the reach of children and pets.
- Only use compatible 18650, or 18500 and adapter, rechargeable batteries (not included/optional) in the auxiliary battery compartment.

14. EXTERNAL POWER SUPPLY

The BOLT-C Series supports the use of an external power supply, such as a 5V mobile power bank. The external power supply may be used with or without the optional auxiliary battery installed.

To connect the BOLT-C to an external power supply:

1. Remove the USB-C port cover **(8)** by turning it counterclockwise.
2. Plug the smaller USB-C end of the data cable into the USB-C port **(9)**.
3. Plug the larger USB end of the data cable into the external power supply. The BOLT-C will automatically switch to using the external power supply for power and it will begin charging the internal battery pack.
 - a. A charging ⚡ icon appears above the battery status indicator for the built-in battery pack in the bottom-right corner of the screen, indicating that the battery is charging. The number of bars and color shown in the battery indicator will change to reflect the current charge level. See **Battery Status Indicators** on page 12.

4. When the external power supply is turned off, the BOLT-C will switch to the auxiliary battery without turning off.
5. If no auxiliary battery is installed or the auxiliary battery level is low, the BOLT-C will switch to the built-in battery pack, instead of shutting down.

NOTE: Do not connect the BOLT-C to an external device with a power supply that exceeds the 3.0 USB cable.

15. MOUNTING THE BOLT-C

To ensure accurate results, please first properly mount the BOLT-C Series on your rifle.

The BOLT-C Series rifle scope is mounted using traditional 30mm ring mounts, such as the ring mounts included in the package. Follow the ring manufacturer's installation instructions and torque the ring caps to 20 in/lbs. A torque driver is required to control the torque.

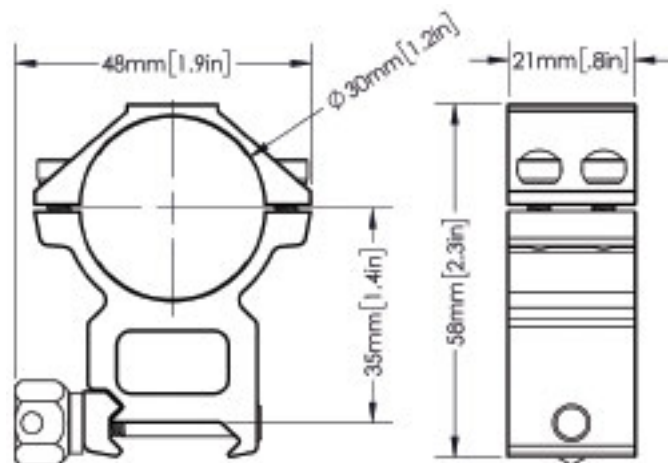

MOUNTING NOTES:

- When mounting the BOLT-C on a rifle, adjust its position so that proper eye relief (50 mm) is achieved. Failure to comply with this recommendation may result in injury to the shooter by the eyepiece when shooting.
- It is recommended to install the BOLT-C as low as possible for a proper cheek weld; however make sure to avoid contact with the barrel or receiver.
- After mounting, but before hunting with the BOLT-C, zero the rifle scope. See **Zeroing the BOLT-C** on page 23 for instructions.

16. OPERATING INSTRUCTIONS

Control Features

The BOLT-C is operated via four control buttons and a large metal tactile control turret. The large, easy-find control turret provides audible and tactile feedback when twisted and when pressed.

The control buttons can be used to perform shortcut operations from the home screen, as well as in the menu and full-screen interfaces. See **Description of Control Buttons and Shortcuts** on page 6 for shortcut button details.

Powering On / Starting



1. Open the objective lens cap (15).
2. Long press the **Power**  **Button** for 2 seconds to power on the BOLT-C.

To determine the current charge of the built-in battery pack, check the battery level indicator in the bottom-right corner of the screen. See **Battery Status Indicators** on page 12.

WARNING: Don't point the objective lens towards any intense energy sources, such as laser radiation or the sun. This may render the electronic components inoperative. The warranty does not cover damage caused by improper operation.

Powering Off / Stopping

To power off the BOLT-C:

1. Press and hold the **Power**  **Button**. The standby screen will open, showing a 3-second countdown.
2. Continue holding the **Power**  **Button** until the 3-second countdown completes.
3. After the countdown completes, "Data saving..." appears on screen and the BOLT-C will shut down automatically after the data finishes saving.

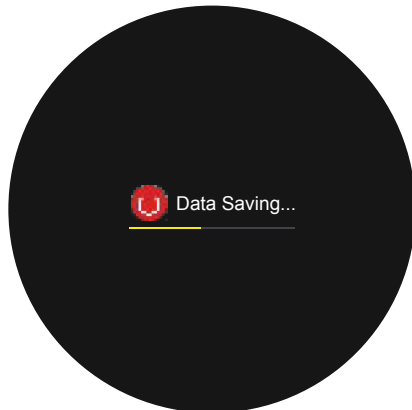

NOTE: Releasing the **Power**  **Button** at any time before the countdown reaches zero will stop the shutdown process and the rifle scope will enter standby mode. Short press the **Power**  **Button** to exit standby.



WARNING: Do not remove the power supply when saving data, otherwise the data may not be saved.

STANDBY MODE

Standby mode may be activated either manually or automatically to conserve the battery life of the rifle scope.

Automatically Enter Standby Mode

In the main menu, the BOLT-C may be set to automatically enter standby mode after a specified time with no operation (2, 4, or 6 minutes). See **Main Menu > Standby** on page 40 for detailed instructions.

1. In the main menu, select the desired standby time, 2 min, 4 min, or 6 min. See **Main Menu > Standby** on page 34 for instructions.
2. The standby icon  and status (2min, 4min, 6min, or off) appear in the bottom status bar.
3. Once set, the BOLT-C will automatically enter standby mode, after the set number of minutes of inactivity, to conserve battery life.
4. Short press the **Power**  **Button** to exit standby and return to the home screen.





NOTES:

- When **2min**, **4min**, or **6min** is selected:
 - The BOLT-C will enter standby mode automatically when the BOLT-C is tilted up or down at an angle of more than 70° or left or right at an angle of more than 30°.
 - The BOLT-C will not enter standby mode while it is in a level position.
- When **off** is selected, standby mode is turned off and the rifle scope will operate until the batteries run out.

Manually Enter Standby Mode

Standby mode may be activated manually from the home screen at any time.

1. Long press the **Power**  **Button** to bring up the shutdown/standby screen. Release the **Power**  **Button** during the 3-second shutdown countdown to manually enter standby mode.
2. Short press the **Power**  **Button** to exit standby and return to the home screen.

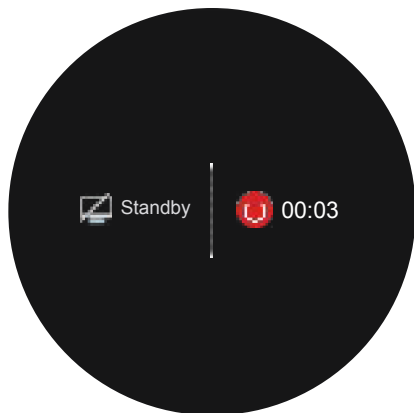

Adjusting the Focus

ADJUSTING THE DIOPTR/YEPIECE

1. Rotate the eyepiece diopter adjustment ring **(2)** at the rear of the rifle scope right or left until the onscreen user interface is clear.
2. Look closely to ensure all icons, the status bars at the top and bottom of the screen, and the reticle appear sharp and in focus. No additional diopter adjustments are required unless the user wishes to make changes.

NOTES:

- After this initial adjustment, there is no need to rotate the eyepiece adjustment ring **(2)** for long distances or any other conditions.
- If necessary during standard use, you may rotate the objective lens focus ring **(14)** to adjust fine focus on the target object being observed. See **Focusing the Objective Lens** below.

FOCUSING THE OBJECTIVE LENS



To adjust the focus on the target object:

1. Rotate the objective lens focus ring **(14)** left or right to focus on the target object being observed.

NOTE: Re-adjusting the focus will be needed if the distance to your target changes.

Activating / Deactivating the Reticle





The reticle is inactive when the BOLT-C is powered on for the first time. To activate the reticle, or to deactivate it at a later time:

1. From the home screen, press and hold the **Brightness**  and **Palette**  **Buttons** at the same time for more than 15 seconds.

Adjusting the Rifle Scope Image Settings

If you did not complete Step 4 Adjust the Image Settings in the Quick Start Guide to adjust the image settings, go ahead and follow the steps below.

From the home screen:

1. Short press the **Palette**  **Button** to set the imaging mode, white hot, black hot, red hot, highlight, or color. White hot is the default.
2. Short press the **Brightness**  **Button** to adjust the screen brightness, from level 1–5. The screen brightness  icon and 5 bars appear at the bottom of the screen. The default is 3.
3. Short press the **Control Turret** to enter the quick menu to adjust the image sharpness, from 1–5. The default is 3. See **Using the Quick Menu** on page 21.
4. Short press the **Power**  **Button** to perform a non-uniformity correction, as needed. See **Non-Uniformity Correction (NUC)** on page 24.
5. Rotate the **Control Turret** to zoom in and out on the observed object. See **Digital Zoom** on page 31.
6. Long press the **Palette**  **Button** to turn on the PIP window, if desired. See **Picture in Picture (PIP)** on page 31.
7. Long press the **Control Turret** to enter the main menu to:
 - a. Turn on Ultra-clear mode to enhance the image contrast in inclement weather, if needed. See **Main Menu > Ultra-clear** on page 34.
 - b. Select the image hue, warm or cold. The default is cold. See **Settings Menu > Image Hue** on page 47.

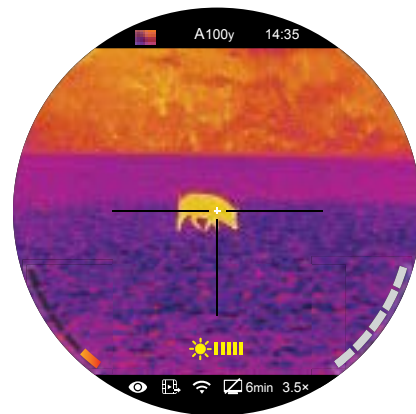

Status Bar Overview

The status bars at the top and bottom of the screen show information on the operating status of the BOLT-C Series:

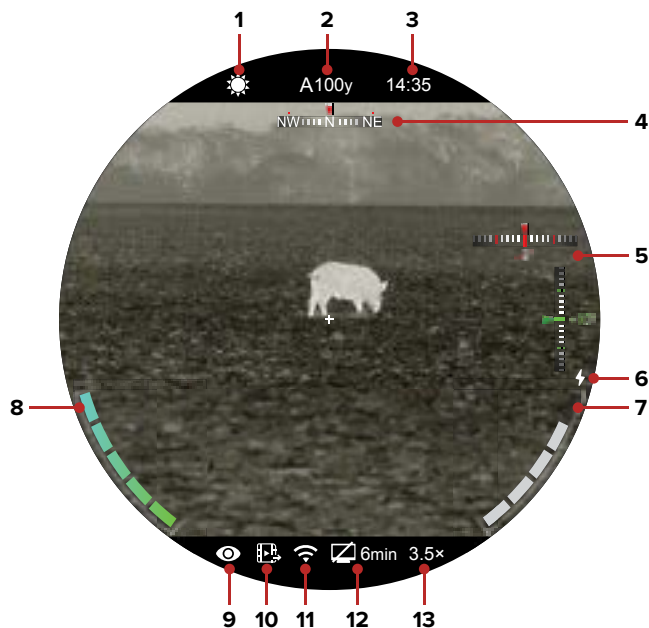

- 1 Imaging Mode:** Shows the set imaging mode, white hot ☀, black hot 🌑, red hot 🔥, color 🌈, and highlight 🐦. White hot is the default.
- 2 Zeroing Profile & Distance:** Shows the selected zero profile (A, B, or C) and the zero distance. A100m is the default.
- 3 Time:** Shows the current time in 24-hour format.
- 4 Digital Compass:** Displays when the compass is turned on. Compass is off by default.
- 5 Gravity Sensor:** The two gravity sensor indicators (tilt and pitch) display when the gravity sensor is turned on. The gravity sensor is off by default.
- 6 Battery Charging:** The battery charging ⚡ icon appears above the battery status indicator for the built-in battery pack when the BOLT-C is connected to an external power source.
- 7 Built-in Battery Status Indicator:** Shows the battery status of the built-in battery pack. When the BOLT-C is receiving power from the battery pack, the battery indicator is in color; when inactive, the battery indicator is gray. See **Battery Status Indicators** on page 12.
- 8 Auxiliary Battery Status Indicator:** Shows the battery status of the rechargeable auxiliary battery. When the BOLT-C is receiving power from the auxiliary battery, the battery indicator is in color; when inactive, the battery indicator is gray. See **Battery Status Indicators** on page 12.

- 9 Ultra-clear Mode:** The ultra-clear 👁 icon displays when ultra-clear mode is turned on. Ultra-clear is off by default.
- 10 Video Output:** The video output 📺 icon displays when video output is turned on. Video output is off by default.
- 11 Wi-Fi:** The Wi-Fi 📶 icon displays when Wi-Fi is turned on. Wi-Fi is off by default.
- 12 Standby:** Shows the standby ⏸ icon and the set time, 2min, 4min, 6min, or off. Standby is off by default.
- 13 Total Magnification:** Shows the total magnification. See **Digital Zoom** on page 31.

Using the Quick Menu

Reticle type, reticle color, image sharpness, and zeroing distance can be set in the quick menu.



- From the home screen, short press the **Control Turret** to enter the quick menu.
- Rotate the **Control Turret** to switch between the quick menu items, described below. The selected menu item is back-highlighted green.
 - Reticle Type:** Short press the **Control Turret** to change reticle type, from 1–6. See **Reticle Types** on the next page.
 - Reticle Color:** Short press the **Control Turret** to change the reticle color between white, black, red, and green.
 - Image Sharpness:** Short press the **Control Turret** to change the image sharpness level, from 1–5.

- d. **Zeroing Distance:** Short press the **Control Turret** to change the selected zeroing distance within the currently selected zeroing profile. Only the zero distances in the selected profile will be available for selection. The selected zeroing distance appears in the top status bar.

3. Long press the **Control Turret** to save changes and exit the menu or wait 5 seconds to save and exit automatically.

RETICLE TYPES

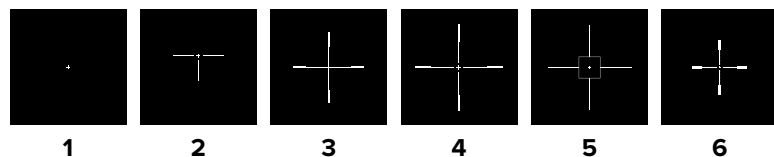

Navigating the Main Menu

From the home screen, long press the **Control Turret** to enter the main menu.



In all menu interfaces:



- Menu icons turn green to indicate the current position in the main menu.
- Submenu options are back-highlighted green to indicate the current position in the submenu.

- Use the **Control Turret** to navigate the menu:
 - **Rotate** to move up and down through the menu to switch between the menu options.
 - **Short press** to change the current parameters for the selected menu option, enter the submenu, or confirm submenu changes.
 - **Long press** to save any changes and exit to the home screen.
- Short press the **Power**  **Button** to return to the previous menu without saving.
- After 15 seconds of inactivity, the menu will automatically close and the interface will return to the home screen.
 - Changes (except changes to toggle on / off menu items, such as Ultra-clear and Wi-Fi) are NOT saved automatically.
- Upon exiting from the main menu the cursor location is stored for a single working session (until the BOLT-C is turned off). After restarting the BOLT-C and entering the menu, the cursor position will be at the first menu item.

17. ZEROING THE BOLT-C

BOLT-C Series features the “freeze” zeroing method. To zero the BOLT-C:

1. Set a suitable target at the desired zero distance.
2. Confirm that the rifle is empty, safe, and pointed in a safe direction, with no ammunition near the weapon.
3. Adjust the image and device settings following the steps in the Quick Start Guide, if you have not done so already. See **Quick Start Guide** on page 8.
4. Select the zeroing profile, A, B, or C. See **Main Menu > Zeroing Profile** on page 36.
5. Based on the distance to the target you wish to zero, select a preset zero distance (100m, 200m, 300m, or 109y, 219y, 328y), OR customize one of the preset zero distances to match. The BOLT-C supports custom zeroing distances of 1 to 999 meters or 1 to 999 yards. See **Zeroing Menu** on page 37.
6. Ensure a stable platform and natural shooting position is achieved behind the rifle.
7. Load ammunition, aim, and take one good shot at the target.
8. Make your rifle safe and observe the location of impact on the target.

9. If the point of impact does not match the point of aim (the center of the reticle):
 - a. In the Reticle Zeroing interface, keep the reticle centered on the point of aim, and long press the **Photo**  and **Palette**  **Buttons** at the same time until the freeze  icon appears at the bottom of the screen. The image is now frozen. See **Zeroing Menu > Reticle Zeroing** on page 38.
 - b. In the Reticle Zeroing interface, adjust the X/Y position of the reticle. See **Zeroing Menu > Reticle Zeroing** on page 38.
10. Take a confirmation shot—the point of impact should now match the point of aim. If not, adjust the X/Y position of the reticle again.

18. NON-UNIFORMITY CORRECTION

A non-uniformity correction (NUC) allows a thermal imager's sensors to correct its pixels and eliminate any image defects caused by pixel drift. The BOLT-C Series has two non-uniformity correction features, automatic shutterless and manual.

Automatic Shutterless NUC: The BOLT-C will perform a NUC automatically according to the internal software algorithm. The shutterless NUC feature helps simplify operation and lowers energy consumption. There is no need to close the objective lens cap **(15)** as the automatic NUC does not use the shutter.

Manual NUC: The user may independently determine the need to perform a NUC based on the quality of the observed image at any time. It is not necessary to close the objective lens cap **(15)** during a manual NUC, as the internal shutter covers the sensor. To perform a manual NUC:

1. From the home screen, short press the **Power**  **Button**.
2. A manual NUC is performed instantly.



19. PHOTOGRAPHY AND VIDEO RECORDING

The BOLT-C is equipped with video recording and image capture. Images and videos are automatically saved on the internal 32 GB memory storage.

Photo and video files are named with the time and date; therefore, it is recommended to set the date and time before using the photo and video functions. See **Settings Menu > Date** and **Settings Menu > Time** on page 45. Alternately, the date and time may be synchronized with one button in the InfiRay Outdoor App. See **Using the InfiRay Outdoor App** on page 30.

Photography

To take a photo:



1. From the home screen, short press the **Photo**  **Button**.
2. The image will freeze for 0.5 seconds and the camera  icon will appear briefly in the upper-left corner of screen.



NOTE: Photos are automatically stored in the internal memory storage.

Video Recording

To record video:

1. From the home screen, long press the **Photo**  **Button** to start a video recording.
2. When the video recording starts, the video recording timer, in HH:MM:SS (hour: minute: second) format, appears in the upper-right corner of the screen.
3. When recording, short press the **Photo**  **Button** to take a photo.
4. Long press the **Photo**  **Button** to stop and save the video recording.



NOTE: All videos and photos will automatically be saved to the internal storage.

Video and Photography Tips

- You may enter and navigate the menu as normal during video recording. The user interface (the status bar, icons, and menu) is not captured in recorded video or photo files.
- Recorded photos are saved to the internal memory card in .jpg format, videos are saved in .mp4 format.
 - a. Photos are saved in IMG_HHMMSS_XXX.jpg format.
 - b. Videos are saved in VID_HHMMSS_XXX.mp4 format.
 - c. HHMMSS is hour/minute/second.

d. XXX is a 3-digit counter number.

- The counter used for the names of multimedia files cannot be reset.
- If a file is deleted from the list, its counter number is not taken by another file.

CAUTION:

- The maximum duration of a recorded video file is 5 minutes. After this time, video recording will begin a new file automatically.
- The number of the recorded files is limited only by the capacity of the internal memory.
- Check the available space of the internal storage card regularly and move the footage to other storage media to free up the memory card space.
- Graphic data (status bar, icons, and menu) are not displayed in the recorded video and photo files.

20. ACCESSING THE INTERNAL MEMORY

When the BOLT-C is turned on and connected to a computer via the included data cable, it is recognized by the computer as a flash memory (USB) drive. This allows the user to access the saved multimedia files and copy or delete any desired files.

To access the internal memory:

1. Turn on the BOLT-C and remove the USB port cover (8).
2. Plug the smaller USB-C end of the data cable into the USB-C port (9).
3. Plug the larger USB end of the data cable into your computer.
4. Double-click **My Computer** on the desktop of your computer.
5. Double-click to open the USB drive named **TH50** or **TH35**.
6. Double-click to open the folder named **Internal Storage** to access the built-in memory.
 - a. Recorded photos and videos are separated by date into folders.
 - b. Folders are named by date, in YYYYMMDD (year/month/day) format.
7. Select the desired files or folders to copy or delete.

21. VIDEO OUTPUT

The video output function enables connectivity with an external display or recording device via analog video.

To output video:



1. In the main menu, turn on video output. See **Main Menu > Video Output** on page 35 for instructions.
2. When video output is on, the video output  icon appears in the bottom status bar.
3. Turn on the BOLT-C and remove the USB-C port cover (8) by turning it counterclockwise.
4. Plug the smaller USB-C end of the data cable into the USB-C port (9).
5. Plug the RCA connector into the RCA port on the external display or recording/display device.



22. CONNECTING TO WI-FI

The BOLT-C has a function for wireless communication with a mobile device (smartphone or tablet) via Wi-Fi.

To enable the wireless module:

1. In the main menu, turn on Wi-Fi. See **Main Menu > Wi-Fi** on page 34 for instructions.
2. When Wi-Fi is on, the Wi-Fi  icon displays in the status bar.
3. When Wi-Fi is on, the Wi-Fi  icon displays in the bottom status bar.



In the InfiRay Outdoor App:

1. Scan one of the QR codes in **Using the InfiRay Outdoor App** on page 30 to download the InfiRay Outdoor App from the App Store or Google Play.
2. Open the app and press the **ViewFinder**  icon at the bottom of the screen.

3. The ViewFinder screen will prompt the user to: Open the mobile device > Go to device settings > Turn on device Wi-Fi > Connect to Wi-Fi.
4. Click the **Connect Device WiFi** button.

On the mobile device:

1. Go to **Settings > Wi-Fi**.
2. Select the BOLT-C from the list of Wi-Fi networks. The BOLT-C will appear in the list as “TH50_XXXXXX” or “TH35_XXXXXX”, where XXXXXX is the six-digit device serial number. See **Settings Menu > Info** on page 49 for the serial number (SN).
3. Enter the Wi-Fi password. The default password is 12345678.
4. Press the **Join** button.

When Wi-Fi is successfully connected, the user may manipulate the BOLT-C via the InfiRay Outdoor App. See **Using the InfiRay Outdoor App** on page 30.



Firmware Upgrade

When a firmware update is available, it may be sent to the BOLT-C through Wi-Fi connection.

To check for and download an available firmware update:

1. On your mobile device, go to irayusa.com/fwpc.
2. If an update is available for the BOLT-C Series, it will be listed at the top of the screen (look for your model number: TH50 or TH35).
3. Click the available update to download it.
4. Confirm you wish to download the file and select where to save the .img file on your mobile device.

To upgrade the BOLT-C:

1. On the BOLT-C, turn on Wi-Fi to connect to the App. See **Main Menu > Wi-Fi** on page 34.
2. Open the InfiRay Outdoor App.
3. In the App, press the **ViewFinder**  icon at the bottom of the screen.
4. Press the **Settings**  icon at top-right.





5. Press the **WiFi Firmware Upgrade** button.
6. Press the **Choose Firmware** button to browse for the saved .img file on your mobile device.
7. Press the **Start Upgrading** button. The app will display the current upload progress. The BOLT-C will automatically reboot when the upgrade has completed.



Setting a New Wi-Fi Password and SSID

The Wi-Fi SSID and password for the BOLT-C Series can be reset in the InfiRay Outdoor App. The default password is: 12345678.

After connecting with a mobile device:

1. Open the InfiRay Outdoor App.
2. Press the **ViewFinder**  icon at the bottom of the screen.
3. Press the **Settings**  icon.
4. In the password field, enter the new Wi-Fi password and tap the **Submit** button. The password must be 8–16 numbers/letters.
5. If you also wish to reset the SSID, enter a new Wi-Fi name in the SSID field.
6. Turn off the BOLT-C to put the new password (and SSID, if changed) into effect.
7. Wait at least 30 seconds before restarting the device.
8. On the mobile device, go to **Settings > Wi-Fi**, enter the new password, and press the **Join** button.





NOTE: When a factory reset is performed, the Wi-Fi password and SSID are reset to the defaults, 12345678 and TH50_XXXXXX or TH35_XXXXXX. See **Settings Menu > Factory Reset** on page 48.

23. USING THE INFIRAY OUTDOOR APP

The BOLT-C Series rifle scope supports operation via the InfiRay Outdoor App when the BOLT-C is connected via Wi-Fi to a smartphone or tablet. See **Main Menu > Wi-Fi** on page 34.

You can download and install the InfiRay Outdoor App for free via any app store, or by scanning one of the QR codes at right to download the InfiRay Outdoor App from the App Store or Google Play.

When Wi-Fi is connected, users can manipulate the BOLT-C via the InfiRay Outdoor App, including:

- Take real-time photos and videos, with or without audio.
- Photos and videos taken via the app are saved to the mobile device, instead of the BOLT-C 's internal storage. Once connected, you can access files saved to the mobile device:
 - In the App, press the **ViewFinder icon**  at the bottom of the screen.
 - Press the photo and video icons at the bottom of the screen to view photos and videos, as well as share, delete, and download files.
- Change the Wi-Fi password and SSID. See **Setting a New Wi-Fi Password and SSID** on page 29.
- Synchronize date and time from the mobile device with the BOLT-C:
 - In the App, press the **ViewFinder icon**  at the bottom of the screen.
 - Press the **Settings icon**  at top-right.
 - Click the **Synchronize Time button**.
- Upgrade the firmware. See **Firmware Upgrade** on page 28.

24. DIGITAL ZOOM

The BOLT-C Series TH50 uses continuous zoom and can quickly increase the base magnification from 3.5× to 14× by enlarging the image from 1 to 4 times digitally.

The TH35 can increase the base magnification from 2.5× to 10× using the same 1 to 4× digital zoom.

To use digital zoom:

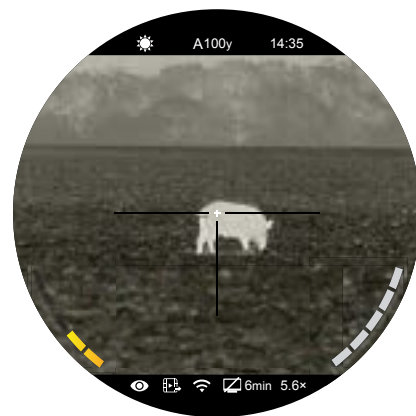

1. From the home screen, rotate the control turret to zoom in and out on the observed object.
 - a. Rotate clockwise to zoom in, counterclockwise to zoom out.
 - b. Each rotation click zooms in / out in increments of 0.35×.
2. The real-time amplification number (3.5–14× for the TH50 or 2.5–10× for the TH35) appears in the bottom status bar.



25. PICTURE IN PICTURE (PIP)

The PIP (Picture in Picture) function opens a small floating window with a magnified image-view at the top of the screen. PIP allows for improved aiming while still being able to see the wide field of view in the main body of the screen.

To activate Picture in Picture (PIP) mode:

1. From the home screen, long press the **Palette**  **Button**. A 2× zoomed image, centered on the reticle, will appear at the top of the screen. Please note that the PIP image is 2× that of the total zoom shown in the bottom status bar.
2. To exit PIP mode, long press the **Palette**  **Button**.

NOTE: When the image in the main body of the screen is enlarged via digital zoom, the PIP image will enlarge accordingly.

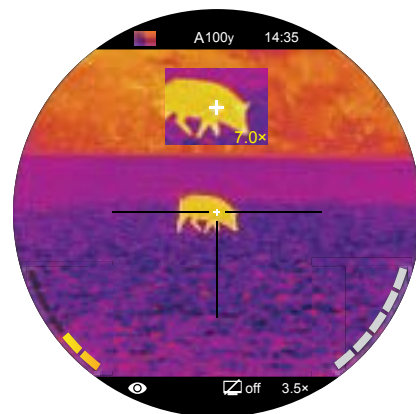

26. STADIAMETRIC RANGEFINDER

The BOLT-C Series is equipped with a stadiametric rangefinder, which allows you to calculate the approximate distance to an object, if its size is known.

To enter the stadiametric rangefinder on:

1. From the home screen, long press the **Brightness**  **Button**.

When the stadiametric rangefinder is open, two horizontal lines which will be used to measure the target object appear in the center of the screen. Icons for three pre-configured objects and their distance values will be displayed on the left side of the screen.

The pre-configured objects and distance values are:

- Deer: 5.6' Tall
- Hog: 3.0' Tall
- Rabbit: 0.7' (7.9") Tall

To use the stadiametric rangefinder to calculate the size of the observed object:

1. Rotate the **Control Turret** to expand or contract the space between the horizontal lines until they touch the top and bottom edges of the target object.
 - a. Rotate clockwise to expand the space between the lines.
 - b. Rotate counterclockwise to shrink the space between the lines.
2. As you adjust the space between the horizontal lines, the rangefinder values on the left side of the screen are automatically recalculated.
3. Long press the **Brightness**  **Button** to exit the stadiametric rangefinder mode.

NOTE:

- The measurement lines are centered on the reticle, which remains onscreen.
- To change the units of measurement (meters or yards), see **Settings Menu > Units of Measure** on page 46.



27. ULTRA-CLEAR MODE

Ultra-clear mode improves the image quality in inclement weather conditions, such as rain, fog, high humidity, or high temperatures as these conditions all result in lower thermal contrast. Ultra-clear mode enhances the NETD value of the thermal sensor and improves the sensor's response rate to these challenging environment conditions.

Ultra-clear mode provides:

- Improved image quality and clarity; images are crisper and sharper.
- Increased image detail.
- Improved recognition of observed targets.

See **Main Menu > Ultra-Clear** on the next page.

28. MAIN MENU OPTIONS AND DESCRIPTIONS

Menu, and submenu, options, from top to bottom are:



- **Main Menu:** Ultra-clear, Wi-Fi, Video Output, Compass, Gravity Sensor, Zeroing Profile, Zeroing, Standby, Pixel Defect Correction, Compass Calibration, and Settings.
 - **Zeroing Menu:** The three preset zero distance options (100m, 200m, and 300m, or 109y, 219y, 328y).
 - **Zeroing Distance Submenu:** Reticle Zeroing, Custom Zero Distance.
 - **Settings Menu:** Date, Time, Language, Units of Measure, Status Auto Hiding, Image Hue, Factory Reset, and Info.

Menu option details, descriptions and navigation instructions are listed in order on the following pages.

Ultra-clear

Turn Ultra-clear mode on / off

Ultra-clear mode improves the image quality in inclement weather conditions, such as rain or fog. See **Ultra-clear Mode** on page 33.



1. Long press the **Control Turret** to enter the main menu.
2. Rotate the **Control Turret** to select the Ultra-clear  menu item. Ultra-clear is selected by default when the menu is accessed for the first time.
3. Short press the **Control Turret** to toggle Ultra-clear mode on / off. Ultra-clear mode is off by default.
4. When ultra-clear mode is on, its icon  appears in the bottom status bar; the icon disappears when Ultra-clear mode is off.
5. Long press the **Control Turret** to save and return to the home screen.

NOTE: When Ultra-clear mode is turned on and off, the BOLT-C will automatically perform a shuttered non-uniformity correction.

Wi-Fi

Turn Wi-Fi on / off

Turn on Wi-Fi to manipulate the BOLT-C via the InfiRay Outdoor App. See **Connecting to Wi-Fi** on page 27.



1. Long press the **Control Turret** to enter the main menu.
2. Rotate the **Control Turret** to move through the menu to select the Wi-Fi  menu item.
3. Short press the **Control Turret** to toggle Wi-Fi on / off. Wi-Fi is off by default.
4. When Wi-Fi is on, its icon  appears in the bottom status bar; the icon disappears when Wi-Fi is off.
5. Long press the **Control Turret** to save and return to the home screen.



Video Output

Turn video output on / off

The video output function enables connectivity with an external display or recording device via analog video. See **Video Output** on page 27.

1. Long press the **Control Turret** to enter the main menu.
2. Rotate the **Control Turret** to move through the menu to select the video output  menu item.
3. Short press the **Control Turret** to toggle video output on / off. Video output is off by default.
4. When video output is on, its icon  appears in the bottom status bar; the icon disappears when video output is off.
5. Long press the **Control Turret** to save and return to the home screen.

Compass

Turn the compass on / off

1. Long press the **Control Turret** to enter the main menu.
2. Rotate the **Control Turret** to move through the menu to select the compass  menu item.
3. Short press the **Control Turret** to toggle the compass on / off. The compass is off by default.
4. When the compass is on, it appears just below the top status bar.
5. Long press the **Control Turret** to save and return to the home screen.



Gravity Sensor

Turn the gravity sensor on / off

1. Long press the **Control Turret** to enter the main menu.
2. Rotate the **Control Turret** to move through the menu to select the gravity sensor  menu item.
3. Short press the **Control Turret** to toggle the gravity sensor on / off. The gravity sensor is off by default.
4. When the gravity sensor is on, the tilt angle (red and gray indicator) appears on the right side of the screen. The pitch angle (green and gray indicator) appears below it.
5. Long press the **Control Turret** to save and return to the home screen.



Zeroing Profile

Select the zeroing profile

To zero the BOLT-C, you must first select a zeroing profile to adjust. Each of the three zeroing profiles, A, B, and C, have three zero distances. These zeroing profiles are displayed in the top status bar as A, B and C, with distance selected.

See the **Zero Distance Submenu** on the next page and **Reticle Zeroing** on page 38 for instructions on customizing the nine zero distances.

1. Long press the **Control Turret** to enter the main menu.
2. Rotate the **Control Turret** to move through the menu to select the zeroing profile  menu item.



3. Short press the **Control Turret** to enter the zeroing profile submenu.
4. Rotate the **Control Turret** to move through the zeroing profile options, A, B, and C.
5. Short press the **Control Turret** to confirm the selection and return to the main menu.
6. The selected zeroing profile, A, B, or C, appears in the top status bar.

Zeroing

Select or customize zero distance

In the zeroing submenus, you can select a preset zero distance, customize a preset zero distance, and adjust the reticle position for the selected zero distance.

Before selecting or customizing a zero distance, you must set a zeroing profile (A, B, or C). Each zero profile has three zero distances. See **Main Menu > Zeroing Profile** on the previous page.

The BOLT-C Series supports custom zeroing distances of 1 to 999 yards or 1 to 999 meters.

1. Long press the **Control Turret** to enter the main menu.
2. Rotate the **Control Turret** to move through the menu to select the zeroing  menu item.
3. Short press the **Control Turret** to enter the zeroing submenu. There are three zero distances shown in the submenu.

ZEROING MENU > ZERO DISTANCE SUBMENU

Select, or customize, a preset zero distance

1. In the Zeroing Menu, rotate the **Control Turret** to select a zero distance option. The preset zero distance options are 100m, 200m, and 300m (109y, 219y, 328y). 100m (109y) is selected by default.



2. Short press the **Control Turret** to enter the submenu for the selected zero distance.
3. In the submenu for the selected zero distance, you may:
 - a. Enter the reticle zeroing interface $\text{---}\frac{1}{1}\text{---}$ to adjust the X/Y position of the reticle at the selected zero distance. See **Reticle Zeroing** below.
 - b. Customize the selected preset zero distance $\text{---}\frac{000\text{m}}{\text{---}}$, if desired. See **Customize Zero Distance** on page 40.

ZEROING MENU > ZERO DISTANCE SUBMENU > RETICLE ZEROING $\text{---}\frac{1}{1}\text{---}$

Adjust the reticle position of the selected zero distance.





In the reticle zeroing interface, the X/Y position of the reticle may be adjusted to match the point of impact. See **Zeroing the BOLT-C** on page 23 for more information.

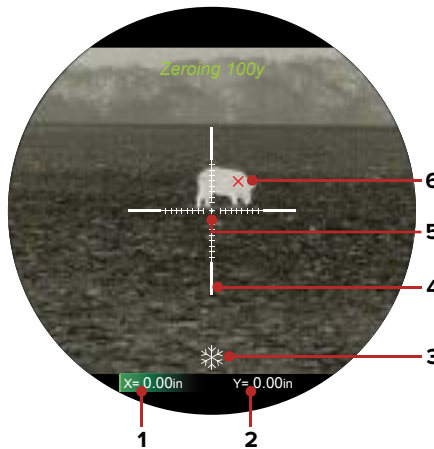

1. In the submenu for the selected zero distance, the reticle zero $\text{---}\frac{1}{1}\text{---}$ menu item is selected by default. Short press the **Control Turret** to select and enter the reticle zeroing interface.
2. The reticle zeroing interface has the following features:
 - 1 **X:** Horizontal point of impact change (in cm or inches).
 - 2 **Y:** Vertical point of impact change (in cm or inches).
 - 3 **Freeze Icon:** Indicates that the image is frozen.
 - 4 **Reticle:** Shows the new reticle position.
 - 5 **White Dot:** Indicates center of initial reticle position.
 - 6 **Red X:** Indicates the point of impact (shown for illustration purposes; not an interface element).



To zero your BOLT-C, either with a preset zero distance or a customized zero distance (see next section for instructions):

1. Aim and shoot at your target.
2. Keep the reticle centered on the aiming point and long press the **Photo**  and **Palette**  Buttons at the same time to freeze the image. The image freeze  icon will appear below the X/Y coordinates.
3. Select the axis (X or Y) along which to move the cursor:
 - a. Short press the **Control Turret** to switch between X and Y. The selected axis is back-highlighted green. The X-Axis is selected by default.
 - b. X (horizontal) is the windage and Y (vertical) is the elevation.
4. Adjust the X/Y position of the reticle until the reticle matches the point of impact.
 - a. Rotate the **Control Turret** counterclockwise to move in the positive direction: X= Right and Y= Up.
 - b. Rotate the **Control Turret** clockwise to move in the negative direction: X= Left and Y= Down.
 - c. Rotate one click to move the reticle in the corresponding direction by 1 pixel. One full rotation (20 clicks) is equivalent to 20 pixels.
 - d. When adjusting your zero at a distance of 50 yards, one click will change the impact point by 0.22" as shown in the X and Y coordinate displays. At 100 yards that same click moves 0.43". At 200 yards one click moves 0.87".
 - e. Changing your zero distance will change the distance of your X/Y adjustments automatically. If your selected zero distance has a correction of 1.30" at 100 yards, it will automatically change to 2.60" if you change the zero distance to 200 yards.
5. Long press **Control Turret** to save the reticle position and return to the home screen; **OR**
 - a. A 5-second countdown appears on the screen, followed by a "Saved Successfully" message.
6. Short press the **Power**  Button to exit the interface without saving the new reticle position.



ZEROING MENU > ZERO DISTANCE SUBMENU > CUSTOMIZE ZERO DISTANCE ^{000m}

Customize a preset zero distance

The BOLT-C Series supports custom zero distances of 1 to 999 yards or 1 to 999 meters.



1. In the submenu for the selected zero distance, rotate the **Control Turret** to select the customization ^{000m} menu item (the selected zero distance will appear instead of “000m”).
2. Short press the **Control Turret** to customize the selected preset zero distance. The selected distance is back-highlighted green and white arrows appear above and below the selected digit to mark the cursor location. The far-left digit is selected by default.
3. Rotate the **Control Turret** to increase or decrease the value of the selected digit, from 0–9.
4. Short press the **Control Turret** to switch between the three digits. The two triangle icons will indicate the selected digit.
5. Long press the **Control Turret** to save the custom zero distance and return to the Zero Distance submenu.
6. The new zero distance appears in the top status bar.



Standby

Set automatic standby status and time

The BOLT-C may be set to automatically enter standby mode after a specified time with no operation (2, 4, or 6 minutes).





1. Long press the **Control Turret** to enter the main menu.
2. Rotate the **Control Turret** to move through the menu to select the standby  menu item.
3. Short press the **Control Turret** to enter the standby submenu.
4. Rotate the **Control Turret** to move through the standby options, off, 2min, 4min, and 6min.

5. Short press the **Control Turret** to confirm the selection and return to the main menu.
6. The standby icon  and status (2min, 4min, 6min, or off) appear in the bottom status bar.
7. Once set, the BOLT-C will automatically enter standby mode, after the set number of minutes of inactivity, to conserve battery life.
8. When in standby mode, short press the **Power**  **Button** to exit and return to the home screen.



NOTES:

- When **2min**, **4min**, or **6min** is selected:
 - The BOLT-C will enter standby mode automatically when the BOLT-C is tilted up or down at an angle of more than 70° or left or right at an angle of more than 30°.
 - The BOLT-C will not enter standby mode while it is in a level position.
- When **off** is selected, standby mode is turned off and the rifle scope will operate until the batteries run out.
- Standby mode may be manually activated from the home screen at any time:
 - Long press the **Power**  **Button** to bring up the shutdown/standby screen. Release the **Power**  **Button** during the 3-second shutdown countdown to manually enter standby mode.
 - Short press the **Power**  **Button** to exit standby and return to the home screen.

Pixel Defect Correction

Select and correct defective pixels

Defective pixels are pixels that do not change correctly compared to the other image pixels—they are either brighter or darker than surrounding pixels. The BOLT-C Series has a tool which corrects any defective pixels on the sensor using its internal software.

1. Long press the **Control Turret** to enter the main menu.
2. Rotate the **Control Turret** to move through the menu to select the pixel defect correction  menu option.

3. Short press the **Control Turret** to enter the defective pixel correction interface.

4. The pixel correction interface has the following features:

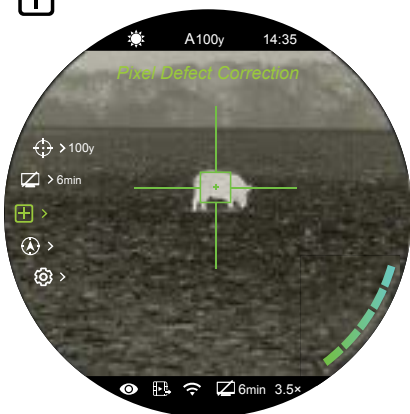

- 1 **X**: Select to move the cursor horizontally.
- 2 **Y**: Select to move the cursor vertically.
- 3  **00**: Shows the number of defective pixels in the “to be corrected” list.
- 4 **Cursor**: Move the cursor to the position of the defective pixel. The cursor appears in the center of the screen in place of the reticle.
- 5 **PIP Window**: Shows a close-up of the cursor location.

5. Select the axis (X or Y) along which to move the cursor:
 - a. Short press the **Control Turret** to switch between X and Y. The selected axis is back-highlighted green. The X-Axis is selected by default.
6. Move the cursor to the location of the defective pixel:
 - a. Rotate the **Control Turret** counterclockwise to move in the positive direction: X= Right and Y= Up.



- b. Rotate the **Control Turret** clockwise to move in the negative direction: X= Left and Y= Down.
- c. Rotate one click to move the cursor in the corresponding direction by 1 pixel. One full rotation (20 clicks) is equivalent to 20 pixels.

7. With the cursor in position, short press the **Power**  **Button** to add the defective pixel to the “to be corrected list.”

- a. **Add** will briefly appear in the bottom-right corner of the PIP window.
- b.  **00** will change to  **01** to indicate that one pixel has been added to the correction list.

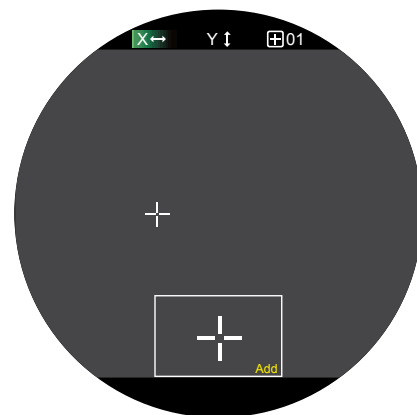

8. If the defective pixel has been added in error, short press the **Power**  **Button** a second time from the same X/Y coordinates (do not move the cursor) to remove the pixel from the “to be corrected list.” **Del** will briefly appear in the PIP window.

9. Repeat the steps above to add additional defective pixels, if needed.

10. When all defective pixels have been added to the list, long press the **Control Turret**.

11. A popup window shows the message “Do you want to keep these settings?” and two options, Yes and No. Yes is selected by default.

12. Short press the **Control Turret** to select **Yes** to correct the defective pixels and return to the home screen; **OR**

- a. A 5-second countdown appears on the screen, followed by a “Saved Successfully” message.

13. Rotate the **Control Turret** to **No** and short press the **Control Turret** to exit to the main menu without correcting any defective pixels.



NOTE: The PIP window will move to the top of the screen when the cursor moves into the bottom of the screen.

Compass Calibration

Calibrate the digital compass

1. Long press the **Control Turret** to enter the main menu.
2. Rotate the **Control Turret** to move through the menu to select the compass calibration  menu item.
3. Short press the **Control Turret** to begin compass calibration.
4. A triaxial coordinate icon will appear on the screen.
5. Follow the prompt to rotate the BOLT-C at least 360 degrees along each axis, X, Y, and Z. Rotations must be completed within the 20-second calibration time.
6. After 20 seconds, the calibration is finished and BOLT-C will automatically exit to the home screen.



Settings

Set general settings

1. Long press the **Control Turret** to enter the main menu.
2. Rotate the **Control Turret** to move through the menu to select the settings  menu item.
3. Short press the **Control Turret** to enter the settings submenu. There are eight submenu items: date, time, language, units of measure, status auto hiding, image hue, factory reset, and info.
4. To make changes to any of the submenu items, use the Control Turret: rotate to navigate to the selected submenu item, short press to select it, rotate to make an adjustment to that menu, and long press to save the adjustment.



SETTINGS MENU > DATE

Set the date

1. In the settings submenu, the date  menu item is selected by default.
2. Short press the **Control Turret** to edit the date. White triangle icons will appear above and below the selected date value. The year value is selected by default. The date is displayed in YYYY.MM.DD format.
3. Rotate the **Control Turret** to select the correct value for each digit (year, month, and day).
4. Short press the **Control Turret** to switch between digits. The two triangle icons indicate the selected digit.
5. Long press the **Control Turret** to save the date and return to the home screen.



SETTINGS MENU > TIME

Set the time

1. In the settings submenu, rotate the **Control Turret** to select the time  menu item.
2. Short press the **Control Turret** to edit the time. White triangle icons will appear above and below the selected time value. The hour value is selected by default. The time is displayed as HH:MM, in 24-hour format.
3. Rotate the **Control Turret** to select the correct value for each digit (hour and minute).
4. Short press the **Control Turret** to switch between digits. The two triangle icons indicate the selected digit.
5. Long press the **Control Turret** to save the time and return to the home screen.



SETTINGS MENU > LANGUAGE

Select the language

1. In the settings submenu, rotate the **Control Turret** to select the language  menu item.
2. Short press the **Control Turret** to enter the language submenu.
3. Rotate the **Control Turret** to move through the language options, English, German, and Russian. English is selected by default.
4. Short press the **Control Turret** to confirm the selection and return to the settings submenu.



SETTINGS MENU > UNITS OF MEASURE

Select the units of measure

1. In the settings submenu, rotate the **Control Turret** to select the units of measure  menu item.
2. Short press the **Control Turret** to enter the units of measure submenu.
3. Rotate the **Control Turret** to move through the options, meters and yards. Meters are selected by default.
4. The selected units of measure (**m** or **y**) will display, along with the selected zero profile and distance, in the top status bar.
5. Short press the **Control Turret** to confirm the selection and return to the settings submenu.



SETTINGS MENU > STATUS AUTO HIDING

Turn auto hiding on/off

This function enables automatic hiding of all interface information, aside from the reticle, for unobstructed image-view.

When auto-hide is turned on, after 8 seconds of inactivity the status bar, digital compass, and all interface icons will be automatically hidden. Shortcut buttons and the menu are disabled until the entire interface is again displayed. Press any button to show all interface information again.

NOTE: When auto-hide is on, the main menu, when open, will hide after 15 seconds of inactivity and the rest of the BOLT-C interface will hide after an additional 8 seconds.

1. In the settings submenu, rotate the **Control Turret** to select the status auto hiding  menu item.
2. Short press the **Control Turret** to enter the status auto hiding submenu.
3. Rotate the **Control Turret** to move through the options, on and off. Auto hiding is off by default.
4. Short press the **Control Turret** to confirm the selection and return to the settings submenu.



SETTINGS MENU > IMAGE HUE

Select the image hue

1. In the settings submenu, rotate the **Control Turret** to select the image hue  menu item.
2. Short press the **Control Turret** to enter the image hue submenu.
3. Rotate the **Control Turret** to move through the hue options, warm and cold. Cold is selected by default.
4. Short press the **Control Turret** to confirm the selection and return to the settings submenu.



SETTINGS MENU > FACTORY RESET

Reset to factory settings

1. In the settings submenu, rotate the **Control Turret** to select the factory reset  menu item.
2. Short press the **Control Turret** to enter the factory reset submenu. Two options, Yes and No, appear; Yes will restore factory settings and No will cancel the operation. Yes is selected by default.
3. Short press the **Control Turret** to select **Yes** to confirm the factory reset. Factory settings will be restored and the BOLT-C will reboot automatically; **OR**
4. Rotate the **Control Turret** to **No** and short press the **Control Turret** to cancel the factory reset and return to the submenu.



NOTES:

- A factory reset cannot be undone.
- The settings listed below will be reset to the factory defaults:
 - Imaging mode: White Hot
 - Display Brightness: 3
 - Image Sharpness: 3
 - Magnification: 3.5x / 2.5x
 - Reticle Type: 1
 - Reticle Color: Black
 - Zeroing: A100m (or A109y)
 - Ultra-clear mode: Off
 - Wi-Fi: Off
 - Video Output: Off
 - Digital Compass: Off
 - Gravity Sensor: Off
 - Standby: Off
 - Date: 2020:01:01
 - Time: 00:00
 - Language: English
 - Units: Meters
 - Status Auto Hiding: Off
 - Image Hue: Cold
 - Wi-Fi SSID: TH50_XXXXXX / TH35_XXXXXX
 - Wi-Fi Password: 12345678

SETTINGS MENU > INFO

Show device information

1. In the settings submenu, rotate the **Control Turret** to move through the submenu and select the info  menu item.
2. Short press the **Control Turret** to enter the info submenu which displays the following information about the BOLT-C: GUI version, SYS Info, boot version, FPGA, PN and SN number, hardware version, and FCC ID.
3. Long press the **Control Turret** to return to the settings submenu.



29. BASIC INSPECTION

It is recommended to carry out a technical inspection before each use. Please check the following:

- The rifle scope appearance: there should be no cracks in the body, or visible damage.
- The condition of the objective lens and eyepiece: there should be no cracks, greasy spots, dirt or other deposits on the lens.
- The internal rechargeable battery pack should be fully charged.
- The control buttons and turret should be in working order.
- The mount should be tight and correctly installed on the rail.

30. BASIC MAINTENANCE

Always replace the objective lens cap (15) after use to avoid damaging or scratching the lens. Never touch the lens directly; oil from your skin can damage the lens coating and surface.

Basic maintenance should be carried out at least twice a year and includes the following steps:

- Wipe the surface of external metal and plastic components with a clean, dry cotton cloth. Do not use chemical, corrosive, or abrasive cleaners. Canned air may also be used to clean the external components.
- Clean the electric contacts and battery slots on the rifle scope using a non-greasy organic solvent.
- Check the lens and eyepiece. If necessary, remove any dirt and sand from the optics; a non-contact cleaning method is preferred.

- Cleaning the exterior of the lens should only be done with the included microfiber lens cloth or similar product. Only clean the lens when it is visibly soiled. Frequent wiping or cleaning can degrade the anti-reflective lens coating.

31. WARRANTY

At iRayUSA we're first and foremost hunters and users of our products and we understand that failure isn't an option. We also understand that having to wait extended periods for repair isn't something that a customer should have to put up with when something does go wrong. During your published warranty period, iRayUSA will repair or replace, at its discretion, any optic that becomes defective during normal use. Additionally, if we cannot fix your optic in less than one week, we will offer to replace it with a replacement product in like or better condition. If you would rather wait for your specific optic to be repaired, we can handle that too.

We know you've never seen this from a thermal manufacturer, neither have we, and that's why we started iRayUSA.

Our warranty follows the product, and is not tied to the original owner. The warranty period is tied to the date of sale to the dealer. This warranty only covers normal use and does not cover cosmetic damage, normal wear, intentional damage, theft, loss, any act of God, or a condition caused by use other than intended. Any product that is modified, opened, or tampered with will void any warranty coverage. Any serial number damage or alteration on the product will be considered modification. Be sure to register your BOLT-C Series rifle scope at irayusa.com/register.

To return a product for repair:

1. Go to irayusa.com/warranty and click the **Request an RMA button** to request an RMA number. Returns will not be accepted without an RMA.
2. The customer is responsible for shipping the product to iRayUSA, to the address below. iRayUSA will return the product at no cost.

iRayUSA
800 Railhead Road #316
Fort Worth, TX 76106

- The one-week timeline starts from the time of receipt of product at iRayUSA.
- iRayUSA is not liable for any damages or loss incurred when shipping to iRayUSA.
- This warranty gives you specific legal rights, and you may also have other rights which vary from state to state.

Please give us a call at **800-769-7125**, visit irayusa.com/warranty, or email info@iRayUSA.com with any questions.

32. GENERAL TROUBLESHOOTING

The troubleshooting table below lists issues that may occur when operating the BOLT-C Series. Carry out the recommended troubleshooting steps in the order shown in the table. Please contact iRayUSA or an authorized vendor for assistance before attempting to perform any modifications or repairs beyond the scope of the troubleshooting procedures in this manual. Unauthorized repairs or modifications will void your warranty.

ISSUE	POSSIBLE CAUSES
The BOLT-C will not turn on.	The built-in battery pack is very low or has completely discharged.
The BOLT-C can not connect to a computer or external power supply.	External power supply has completely discharged.
	Computer is turned off.
	Data cable is damaged.
Video output is not working.	Video output is not turned on
The BOLT-C can not connect to the mobile device (smartphone or tablet).	Wi-Fi is not turned on.
	Wrong Wi-Fi password entered.
	Too many Wi-Fi signals near the BOLT-C.

TROUBLESHOOTING STEPS
Charge the built-in battery pack.
Check the external power supply and charge it if necessary.
Power on the computer.
Replace the USB-C to analog RCA/USB data cable.
Turn on video output in the main menu. See Main Menu > Video Output on page 35.
Turn on the Wi-Fi in the main menu. See Main Menu > Wi-Fi on page 34.
On the mobile device, go to Settings > Wi-Fi and enter the correct password. The default password is 12345678. See Main Menu > Wi-Fi on page 34.
Move the BOLT-C and mobile device to an area with no or fewer Wi-Fi signals.

ISSUE	POSSIBLE CAUSES
Wi-Fi signal is lost or interrupted.	Smartphone or tablet is out of range of a strong Wi-Fi signal, or there are obstacles between the BOLT-C and the mobile device.
The image is fuzzy, not clear, not balanced, with artifacts.	Non-uniformity correction is required.
The image is too dark.	Display brightness level is too low.
The GUI is clear, but the image is fuzzy.	The lens is not focused.
	There is dust on the interior or exterior optical surfaces of the lens.
	There is condensation on the interior or exterior optical surfaces of the lens.
The aiming reticle shifts after firing rounds.	The BOLT-C is not mounted securely or the mount is not secured on the BOLT-C.
The image of the object being observed is missing.	Looking through glass.
The BOLT-C will not focus.	Image settings are not optimal for the current environmental conditions or the object being observed.
Image quality is too low or the detection range is reduced.	These issues may occur due to the weather conditions, such as snow, rain, humidity, and fog.
When the BOLT-C is used in low temperature conditions, the image quality of the surroundings is worse than in warm temperature conditions.	Environmental conditions.

TROUBLESHOOTING STEPS
<ul style="list-style-type: none"> Try again when Wi-Fi signal is stable. Relocate the BOLT-C closer to the Wi-Fi signal.
Perform a non-uniformity correction. See Non-uniformity Correction on page 24.
From the home screen, short press the Brightness button to adjust the display brightness.
<ul style="list-style-type: none"> Adjust the focus on the target by rotating the Objective Lens Focus Ring (14) Adjust the image sharpness in the quick menu. See Using the Quick Menu on page 21.
<ul style="list-style-type: none"> Wipe the outside optical surfaces with the included microfiber lens cloth.
<ul style="list-style-type: none"> Wipe the outside optical surfaces with the included microfiber lens cloth. Allow the BOLT-C to dry by leaving it in a warm, dry environment for at least 4 hours.
<ul style="list-style-type: none"> Check that the BOLT-C has been securely mounted. Make sure you are using the same brand, type, and weight of the bullets as when the BOLT-C and weapon were initially zeroed. If the BOLT-C was zeroed in different environmental conditions, a slight shift of the zero is possible.
Remove any glass windows from the field of view.
<ul style="list-style-type: none"> Check the outer surfaces of the objective lenses and eyepiece and, where necessary, wipe away any dust, condensation, frost, etc. In cold weather, you can use special anti-fogging coatings, such as those made as for corrective glasses. Adjust the focus on the target by rotating the Objective Lens Focus Ring (14). Adjust the image sharpness in the quick menu. See Using the Quick Menu on page 21. Adjust the image and device settings. See Quick Start Guide on page 8. Turn on Ultra-clear mode. See Main Menu > Ultra-clear on page 34.
Turn on Ultra-clear mode. See Main Menu > Ultra-clear on page 34.
In warm temperature conditions, objects being observed (surroundings and background) heat up differently because of thermal conductivity, thereby generating a high temperature contrast. Accordingly, image quality produced by the riflescope will be higher. In low temperature conditions, the background will cool down to roughly the same temperature, and thus the temperature contrast is substantially reduced and image detail can go down as there is less contrast in the scene. This is a normal function of a thermal imager and is no indicator of actual detector performance.



**800 Railhead Road #316
Fort Worth TX 76106
800-769-7125
682-499-0047
info@irayusa.com**